

Windows Glass walls





Always a comprehensive choice.

Windows represent a decades-long investment. Each one is individually designed, built and fitted for you. For your building, your façade, your interior. Once installed, it provides a link between indoors and outdoors for decades. A long period of time during which quality pays dividends. This is exactly why careful planning and design are so worthwhile. So familiarise yourself with the numerous useful functions of modern windows. Discover the wealth of aesthetic options – and fashion your own dream windows.

Here, Finstral offers you the ideal range from which you can freely choose. A range so modular that everything fits with everything else, a particularity for which we have gained a reputation. To set alongside other features, such as the slender frames, high-quality materials and excellent performance values of our products – from traditional windows to sliding and folding elements and entire glass walls. Take a look for yourself: by browsing through the catalogue or visiting a Finstral Studio, where you will be treated to a first-hand experience of the unlimited variety of our windows. We look forward to seeing you – whenever that may be!



Florian, Joachim and Luis Oberrauch

Finstral Board of Directors



From left to right: Florian, Joachim and Luis Oberrauch

Contents

10

The Finstral Planner for windows and glass walls

6

Discover what makes a window perfect.

Mediating between indoors and outdoors, windows are our constant companion – for decades. Find out why it is worthwhile to design them carefully, with Finstral.

from 54

Interviews and insights



78

Engineer Robert Krippahl

“We go about it like burglars.”

54

Architect Perrine Ernest

“Windows give form to entire buildings.”

Exterior

The façade side

12

→ Design

You can make use of materials, colours, finishes, frame shapes and style elements to design the exterior of your windows.

74

→ Protection

Windows protect against burglars, sun/heat, insects and prying eyes: here you can find the necessary fittings.

Centre

The core

118

→ Insulation

Heat/cold, noise and tightness: Finstral windows are always perfectly insulated – and offer a wide range of options.

138

→ Building connection

You can rely on us to deliver the ideal installation method for every situation – and on our certified installation quality.



92

Professor Peter Andres

“Daylight is a basic nutritional requirement.”

134

Engineer Ruben Erlacher

“The window plays a key role in sound insulation.”



126

Systems engineer Franz Gufler

“uPVC is the ideal material for windows.”

156

Technical consultant Timo Sachse

“The phrase ‘next to no time’ was invented for this.”

Interior

The living side

168

→ Design

Use materials, colours, finishes, frame shapes and handles to craft your windows and make them part of your interior.

206

→ Operation

From opening action to barrier-free access and ventilation: configure your windows for your own personal comfort.

Ancillary services

Support

246

→ Procedure

Coordination, delivery, installation, acceptance: we make sure that your order runs smoothly.

262

→ Support

Our warranties and certifications vouch for lasting quality. We are there to help you even after installation.

278

The world of Finstral

We are a South Tyrolean family business – all key production steps are carried out in-house.

288

Range

292

Index



238

Scientist Annamaria Belleri

“Build tightly – ventilate properly: the maxim for energy efficiency.”

220

Customer consultant Lorraine Elsman

“FIN-Slide stands for the ultimate reduced look.”



272

Architects on Finstral

“We also have Finstral to thank for the built result.”



254

Is a replacement worthwhile?

Why not perform the Window-Check?

232

Product expert Gustav Burger

“For thresholds, barrier-free access is just one of many requirements.”

Discover what makes a window perfect.

Windows provide a link between indoors and outdoors. We all use them every day without a second thought – for decades. Make sure you take the necessary time to design your windows with care and pleasure.

A sense of well-being.

We need light to live. We seek reliable protection and like to handle everyday things with a minimum of effort. Your new windows should admit plenty of daylight – and set standards in terms of insulation, burglary protection and user comfort.





A vision of beauty.

A place only becomes a home when we fashion it ourselves. Windows play a pivotal role in this regard: on the outside, they shape the architecture, on the inside, the style of fit-out. Hence the importance of having your new windows individually designed.



A commitment to sustainability.

Responsibility cannot be delegated. This applies just as much to the use of energy and resources. So not only must your new windows help you to save energy, they must also be highly durable, resource-friendly in their production and fully recyclable.

Windows are part of your life.

Inside is your home. Outside lies the world. Between them: the windows. They give character to the façade while adding style and expression to the indoor spaces. Finstral windows vouch for light, air and views while efficiently keeping out noise, sunshine, heat, cold, water ... and burglars. Finstral's windows and glass walls do far more than meets the eye. And they lend themselves to a much wider variety of designs than you can possibly imagine.



Each window is unique.

Finstral's windows and glass walls are custom-assembled for each order and application in line with the specified size, shape, material, colour, fittings and, not least, mounting method. Thanks to their intelligent and systematically built-in modularity, only Finstral windows allow practically free combination of all components with each other – because everything fits with everything else. Perfectly geared to one set of needs: yours.





Perfect windows from a single source.

If you want something done properly, do it yourself. That is why Finstral develops and manufactures virtually all window and glass wall components itself – in its own production facilities, exclusively in Europe. Handling everything from uPVC extrusion and aluminium coating to glass and wood production. From the frame profiles to the installation method. Designed with modular coordination for perfect interaction.

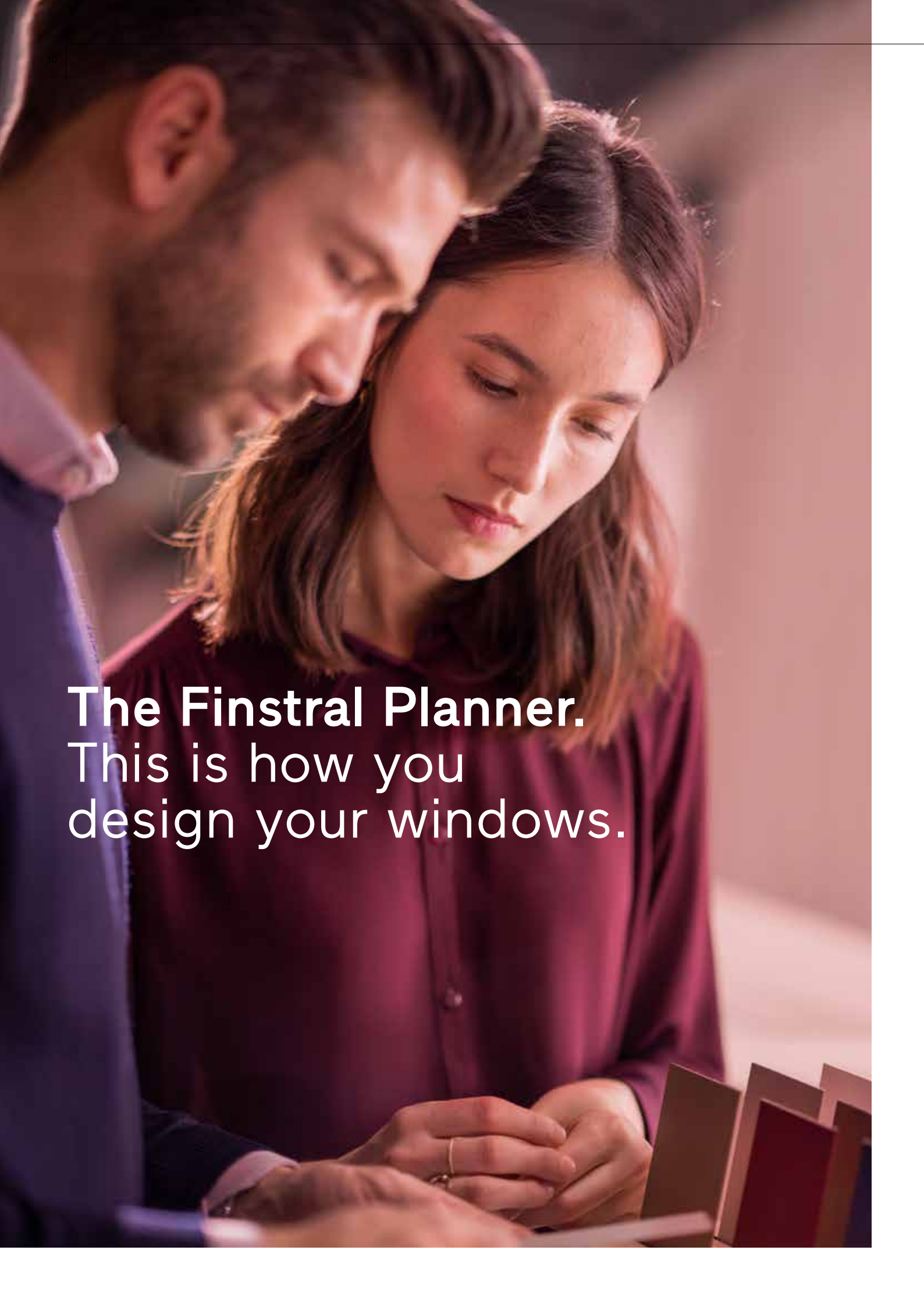
A man and a woman are looking at a laptop screen together. The man is on the left, leaning in, and the woman is on the right, looking down at the screen. They appear to be in a professional setting, possibly a meeting or a collaborative work environment. The lighting is warm and focused on the subjects.

The Finstral Planner.
This is how you
design your windows.



Exterior

The façade side

→ Design	12
Material	14
Colour/Finish	16
Frame shape	28
Style elements	68
→ Protection	74
Burglary	76
Sun/Heat	90
Privacy	114
Insects	116



Centre

The core

→ Insulation	118
Heat/Cold	120
Noise	128
Tightness	136
→ Building connection	138
Mounting method	140
Sealing	166



Interior

The living side

→ Design	168
Material	170
Colour/Finish	172
Frame shape	186
Handles/Hinges	196
Accessories	203
→ Operation	206
Opening actions	208
User comfort	230
Safety in use	234
Ventilation	236



Ancillary services

Support

→ Procedure	246
Coordination	248
Installation	258
Acceptance	260
→ Support	262
Warranties/	
Certificates	264
Customer service	268
Architect service	270
Sustainability	276

We at Finstral always plan in four dimensions.

Our range of windows and glass walls offers you high-quality design without functional compromises. Whether technical features or aesthetic details: (almost) everything is combinable with everything else. In addition, thanks to the clear structure of the Finstral Planner, you can always keep an eye on the big picture when designing your desired windows.

Exterior → Design
The façade side
of your windows.



Material
Colour/Finish
Frame shape
Style elements



Material

→ Frame and sash

On the outside uPVC, aluminium or both.

For the exterior face, you can choose between uPVC, aluminium or a combination of the two. Both materials are versatile in terms of design, extremely durable, fully recyclable, weather-resistant and very easy to clean. Production at Finstral also uses extra-high quality materials. Moreover, our frame profiles are designed in such a way as to allow only the window frame or only the sash frame to be fitted with an aluminium facing, e.g. to create two-tone effects.

With the Nova-line option, the window sashes can also be designed without a visible frame.

More information can be found under [Exterior → Design → Frame shape → Nova-line](#)

The window core always comprises perfectly insulating uPVC.

More information can be found under [Centre → Insulation](#)

uPVC of the highest quality

In 1969, Finstral's founders embraced a new idea: windows made from uPVC – now the most widely used frame material throughout Europe. And for a good reason: uPVC is highly durable, offers perfect thermal insulation, allows weathertight welding at corners, and is fully and readily recyclable. Over 40 years ago, Finstral dispensed with the otherwise common practice of sourcing its uPVC profiles from suppliers and started manufacturing them itself – from uPVC granulate with a high proportion of recycled material based on an extra-high-quality formulation. This lends them lasting dimensional stability, colour-fastness and weather resistance while delivering high-quality recycle at the end of their service life.

For more information: finstral.com/strong-stuff

Aluminium of the highest quality

With their more angular look, windows with aluminium frames are considered elegant and contemporary. They can also be coated in any desired colour while always remaining heat-stable and easy to clean. They retain their shape even when exposed to strong sunlight. Water and dirt simply bead off to make cleaning easy. Finstral now deploys its own powder coating facility to deliver aluminium facings with an extra-high-grade finish that meets the particularly stringent Qualicoat Seaside standard.

Exterior material combinations uPVC sash frame

uPVC window frame



Aluminium window frame



Exterior → Design → Colour/Finish → uPVC

Aluminium sash frame

Glass sash frame



Exterior → Design → Colour/Finish →
Aluminium

Exterior → Design → Colour/Finish →
Enamelled glass

Colour/Finish → uPVC

Colours galore, quality to the fore.

Finstral has been producing uPVC profiles in-house for decades and, having perfected its surface finishing techniques, turns out products that meet the utmost standards in terms of look and touch. Regardless of the finish – extra smooth, embossed or satin – the high-quality base material ensures that the colours and surface textures are perfectly expressed, with durability guaranteed.

You can find our uPVC-wood decors under [Exterior → Design → Colour/Finish → Wood decor](#)

Through-coloured material, light-fast colours.

Our uPVC components are always through-coloured and not just film-coated, thereby lending the window a top-quality appearance, even when open. The light-sensitive grey tones receive additional, thermally laminated UV protection. Given the susceptibility of dark uPVC profiles to deformation under exposure to sunlight, we deliberately offer dark shades only in heat-resistant aluminium.

Easy-care with high-grade finish.

Top-quality finishes, achieved through the compression and finishing operations during extrusion, have been Finstral's hallmark since 1984. At Finstral, textures are directly embossed into the material and not stuck on as a film – this delivers homogeneous finishes that are also scratch- and dirt-resistant.

Smooth classic glossy

01

White
extra smooth

Embossed lacquered wood look

42

White
embossed

07

Pearl White
embossed

Uniquely easy-care.

Only Finstral seals the dirt-sensitive micropores of its uPVC profiles by compressing these during extrusion. This prevents dust from settling.

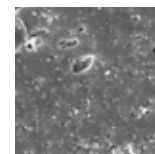

Compressed surface of an extruded, extra-smooth Finstral uPVC profile (heavily magnified).

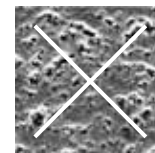

Conventional smooth finish of an extruded uPVC profile (heavily magnified).

Satin finish simple and modern

45

White
satin finish

27

Pearl White
satin finish

46

Silk Grey
satin finish

06

Grey
satin finish

Only Finstral finishes all uPVC surfaces, such as these in Pearl White embossed, Silk Grey satin finish, Grey satin finish and White extra smooth, by means of high-grade, durable (blind) embossing.



Colour/Finish → Wood decor

Whether uPVC or aluminium: always with the look of natural wood decors.

Do you adore the aesthetics of wood, but nonetheless wish to have permanently easy-care windows? With its wide range of wood decors, Finstral offers you a wealth of high-quality, weather-resistant finishes – made of uPVC or aluminium.

uPVC-wood decor.

Available in three colours, our uPVC-wood decors are hardly distinguishable to the eye from real wood while being much easier to clean and less sensitive to sunlight, moisture, scratches and dirt. To imitate the appearance of wood, the decor is thermally laminated in the uPVC and the grain embossed in the surface. The frame is also completely through-coloured in a matching brown tone.

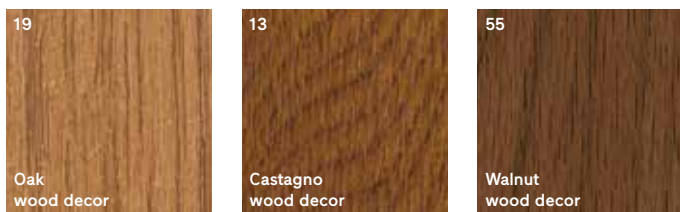

Extra-robust.

Thermally laminated in through-coloured uPVC, the wood decor offers greater resistance to damage. As the cross-cut test shows, the standard market practice of bonding the wood decor film to white frame profiles means that any damage is visible.

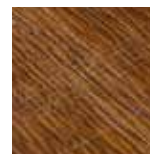

Finstral uPVC finishes with wood decor pass the cross-cut test to DIN EN ISO 2409.



Standard uPVC finishes have a bonded wood decor film that becomes easily detached when damaged.

Aluminium-wood decor.

Our ten high-grade aluminium-wood decors look deceptively genuine – though are far easier to clean than the original. Aluminium exhibits high dimensional stability even under heavy heat and moisture exposure. In sunny climates, this makes aluminium the best choice for windows with a dark wood finish.

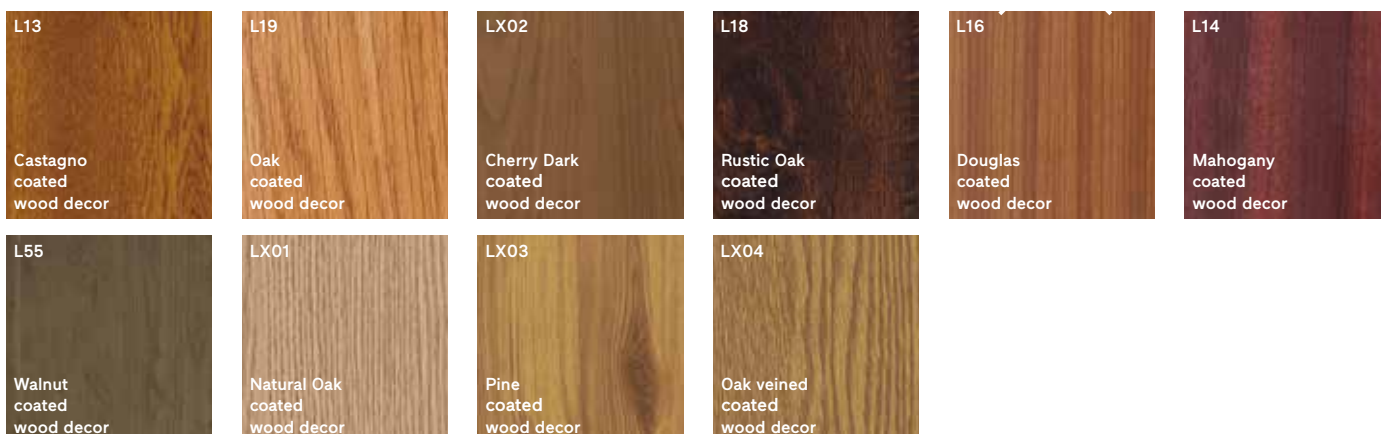

Our wood decors boast the appearance of real wood, though are less sensitive to scratches, dirt and weathering – here aluminium-wood decor in L13 Castagno coated, aluminium-wood decor in LX02 Cherry Dark coated and uPVC-wood decor in 19 Oak.



Colour/Finish → Aluminium

Maximum colour variety.

Choose from around 250 colours: the high-quality powder coating applied in-house in accordance with the stringent Seaside Qualicoat standard vouches for permanent colour brilliance.

Full-strength colours based on RAL colour range.

M100 Green Beige matt	M101 Beige matt	M102 Sand Yellow matt	M103 Signal Yellow matt	M104 Golden Yellow matt	M105 Honey Yellow matt	M106 Maize Yellow matt	M107 Daffodil Yellow matt
M111 Brown Beige matt	M112 Lemon Yellow matt	M113 Pearl White matt	M114 Ivory matt	M115 Light Ivory matt	M116 Sulphur Yellow matt	M117 Saffron Yellow matt	M118 Zinc Yellow matt
M119 Grey Beige matt	M120 Olive Yellow matt	M121 Rape Yellow matt	M123 Traffic Yellow matt	M124 Ochre Yellow matt	M127 Curry Yellow matt	M128 Melon Yellow matt	M132 Broom Yellow matt
M133 Dahlia Yellow matt	M134 Pastel Yellow matt	M137 Sun Yellow matt	M200 Yellow Orange matt	M201 Red Orange matt	M202 Blood Orange matt	M203 Pastel Orange matt	M204 Pure Orange matt
M208 Bright Red Orange matt	M209 Traffic Orange matt	M210 Signal Orange matt	M211 Deep Orange matt	M212 Salmon Orange matt	M300 Flame Red matt	M301 Signal Red matt	M302 Carmine Red matt
M303 Ruby Red matt	M304 Purple Red matt	M305 Wine Red matt	M307 Black Red matt	M309 Oxide Red matt	M311 Brown Red matt	M313 Tomato Red matt	M314 Antique Pink matt
M315 Light Pink matt	M316 Coral Red matt	M317 Rose matt	M318 Strawberry Red matt	M320 Traffic Red matt	M322 Salmon Pink matt	M331 Orient Red matt	M401 Red Lilac matt
M402 Red Violet matt	M403 Heather Violet matt	M404 Claret Violet matt	M405 Blue Lilac matt	M406 Traffic Purple matt	M407 Purple Violet matt	M408 Signal Violet matt	M409 Pastel Violet matt

Our aluminium can be coated in over 200 colours, including most of the shades in the RAL range – with a matt or finely textured finish.

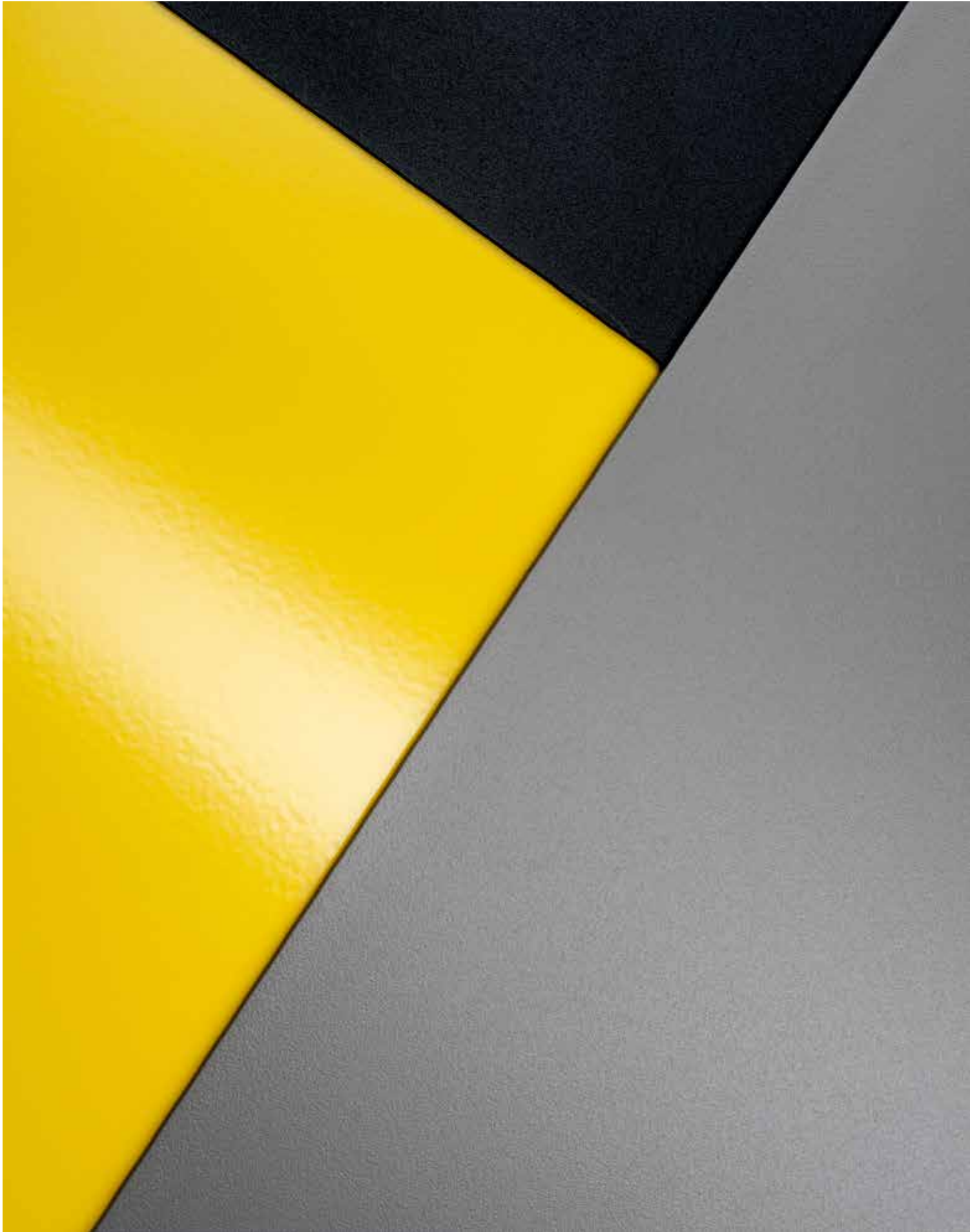

Colour/Finish → Aluminium

Full-strength colours continued.

M410 Telemagenta matt	M411 Pearl Violet matt	M412 Pearl Blackberry matt	M500 Violet Blue matt	M501 Green Blue matt	M502 Ultramarine Blue matt	M503 Sapphire Blue matt	M504 Black Blue matt
M505 Signal Blue matt	M507 Brilliant Blue matt	M508 Grey Blue matt	M509 Azure Blue matt	M510 Gentian Blue matt	M511 Steel Blue matt	M512 Light Blue matt	M513 Cobalt Blue matt
M514 Pigeon Blue matt	M515 Sky Blue matt	M517 Traffic Blue matt	M518 Turquoise Blue matt	M519 Capri Blue matt	M520 Ocean Blue matt	M521 Water Blue matt	M522 Night Blue matt
M523 Distant Blue matt	M524 Pastel Blue matt	M600 Patina Green matt	M601 Emerald Green matt	M602 Leaf Green matt	M603 Olive Green matt	M604 Blue Green matt	M605 Moss Green matt
M606 Grey Olive matt	M607 Bottle Green matt	M608 Brown Green matt	M609 Fir Green matt	M610 Grass Green matt	M611 Reseda Green matt	M613 Reed Green matt	M614 Yellow Olive matt
M615 Black Olive matt	M616 Turquoise Green matt	M617 Maize Green matt	M618 Yellow Green matt	M619 Pastel Green matt	M620 Chrome Green matt	M621 Pale Green matt	M622 Brown Olive matt
M624 Traffic Green matt	M625 Fern Green matt	M626 Opal Green matt	M627 Light Green matt	M628 Pine Green matt	M629 Mint Green matt	M632 Signal Green matt	M633 Mint Turquoise matt
M634 Pastel Turquoise matt	M637 Pure Green matt	M700 Squirrel Grey matt	M701 Silver Grey matt	M702 Olive Grey matt	M703 Moss Grey matt	M704 Signal Grey matt	M705 Mouse Grey matt
M706 Beige Grey matt	M708 Khaki Grey matt	M709 Green Grey matt	M710 Tarpaulin Grey matt	M711 Iron Grey matt	M712 Basalt Grey matt	M713 Brown Grey matt	M715 Slate Grey matt

M716 Anthracite Grey matt	M721 Black Grey matt	M722 Umbra Grey matt	M723 Concrete Grey matt	M724 Graphite Grey matt	M726 Granite Grey matt	M730 Stone Grey matt	M731 Blue Grey matt
M732 Pebble Grey matt	M733 Cement Grey matt	M734 Yellow Grey matt	M735 Light Grey matt	M736 Platinum Grey matt	M737 Dust Grey matt	M738 Agate Grey matt	M739 Quartz Grey matt
M740 Window Grey matt	M742 Traffic Grey A matt	M743 Traffic Grey B matt	M744 Silk Grey matt	M745 Telegrey 1 matt	M746 Telegrey 2 matt	M747 Telegrey 4 matt	M748 Pearl Mouse Grey matt
M800 Green Brown matt	M801 Ochre Brown matt	M802 Signal Brown matt	M803 Clay Brown matt	M804 Copper Brown matt	M807 Fawn Brown matt	M808 Olive Brown matt	M811 Nut Brown matt
M812 Red Brown matt	M814 Sepia Brown matt	M815 Chestnut Brown matt	M816 Mahogany Brown matt	M817 Chocolate Brown matt	M819 Grey Brown matt	M823 Orange Brown matt	M824 Beige Brown matt
M825 Pale Brown matt	M828 Terra Brown matt	M901 Cream White matt	M902 Grey White matt	M903 Signal White matt	M904 Signal Black matt	M905 Jet Black matt	M906 White Aluminium matt
M907 Grey Aluminium matt	M910 Pure White matt	M911 Graphite Black matt	M916 Traffic White matt	M917 Traffic Black matt	M918 Papyrus White matt	M922 Pearl Light Grey matt	9017 Traffic Black glossy
F05 Antique White fine texture	F09 Azure White fine texture	F113 Pearl White fine texture	F119 Grey Beige fine texture	F305 Wine Red fine texture	F45 White satin finish fine texture	F511 Steel Blue fine texture	F609 Fir Green fine texture
F612 Black Green fine texture	F702 Olive Grey fine texture	F703 Moss Grey fine texture	F716 Anthracite Grey fine texture	F721 Black Grey fine texture	F722 Umbra Grey fine texture	F723 Concrete Grey fine texture	F739 Quartz Grey fine texture
F742 Traffic Grey fine texture	F744 Silk Grey fine texture	F819 Grey Brown fine texture	F90 Grey White fine texture	F905 Jet Black fine texture	F91 Pebble Grey fine texture	F918 Papyrus White fine texture	F92 Platinum Grey fine texture
F93 Orange Brown fine texture	F94 Olive Brown fine texture	F95 Terra Brown fine texture	L05 Antique White glossy	M01 White matt	F958 Canal Green fine texture		

Colour/Finish → Aluminium

Special effect colours.

Whether sablé tones with a slightly grainy texture or metallic variants – these colours produce vivid, ever-surprising reflections.

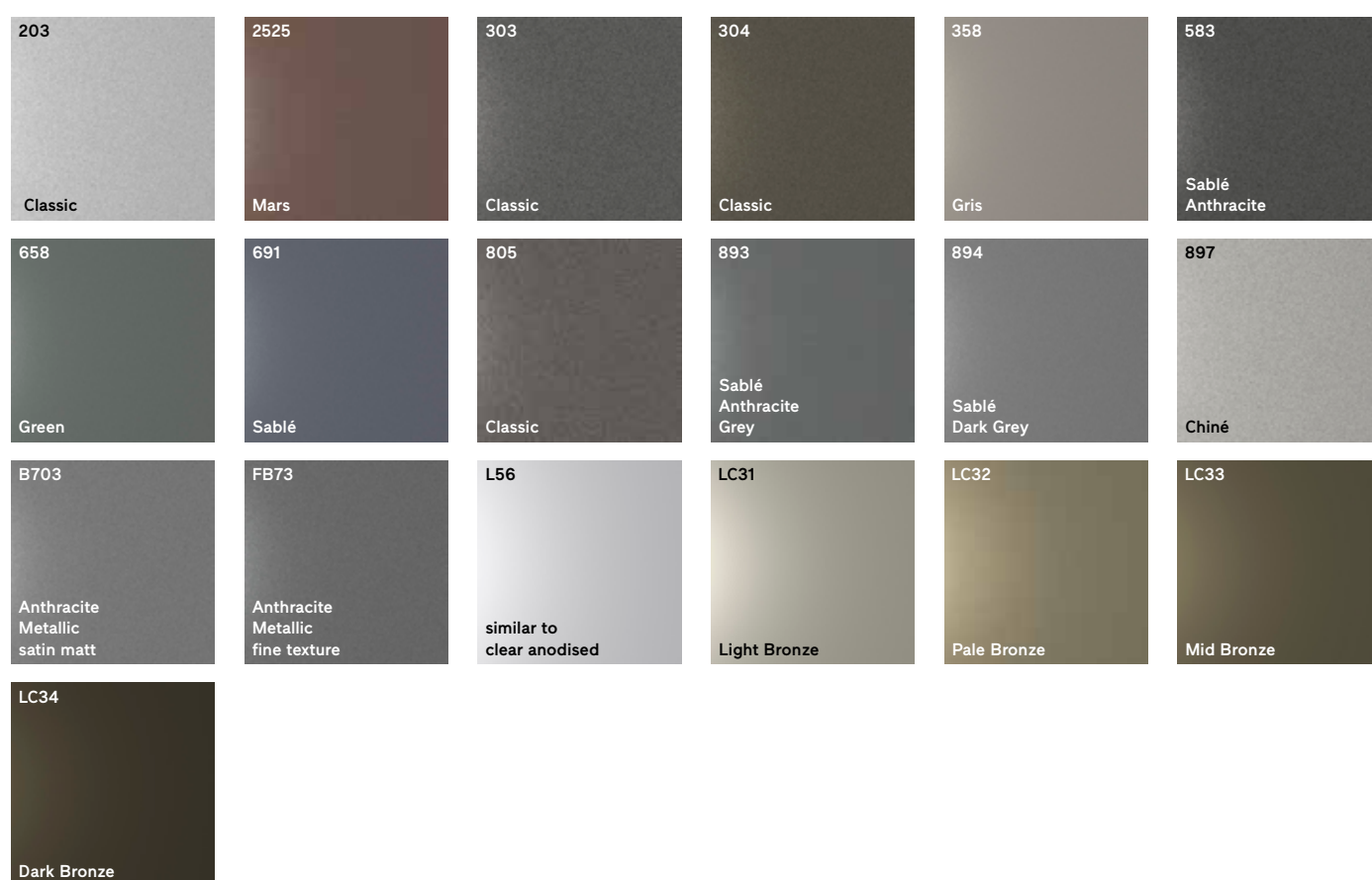

Special colours.

Our aluminium finishes can also be designed with NCS and DB colours on request. Only DB703 is in our standard colour range. Please feel free to contact us!

Wood decors.

You can find our aluminium-wood decors under [Exterior → Design → Colour/Finish → Wood decor](#)

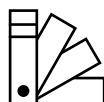

Colour representation similar.

Binding colour samples are available from your specialist consultant or at finstral.com/samples

Lasting dimensional stability.

Finstral always provides dark frame profiles with a dimensionally stable aluminium facing. As uPVC has a softening point of just below 80 °C, dark-coloured profiles will irreparably deform under permanent exposure to sunlight.



Dark uPVC heats up quickly and has a tendency to distort due to its softening point below 80 °C.



Dark aluminium remains dimensionally stable even under heavy heat exposure.

We also offer special effect and special colours for our window designs. Here: LC32 Pale Bronze, B703 Anthracite Metallic satin matt, 203 Classic and 583 Sablé Antracite.



Colour/Finish → Enamelled glass

Brilliantly rich colours.

We can produce highly elegant frameless sashes or opaque sublights with glass enamelled on the rear face. Baking the coloured enamel into the glass makes the warm natural tones of the glass surfaces particularly brilliant and durable. The easy-care surfaces are produced in the hardening furnace at our own glass production facility – in time-honoured Finstral quality.

Enamelled glass.

The smooth, reflective surface enhances the radiance of the colours.

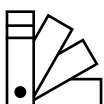
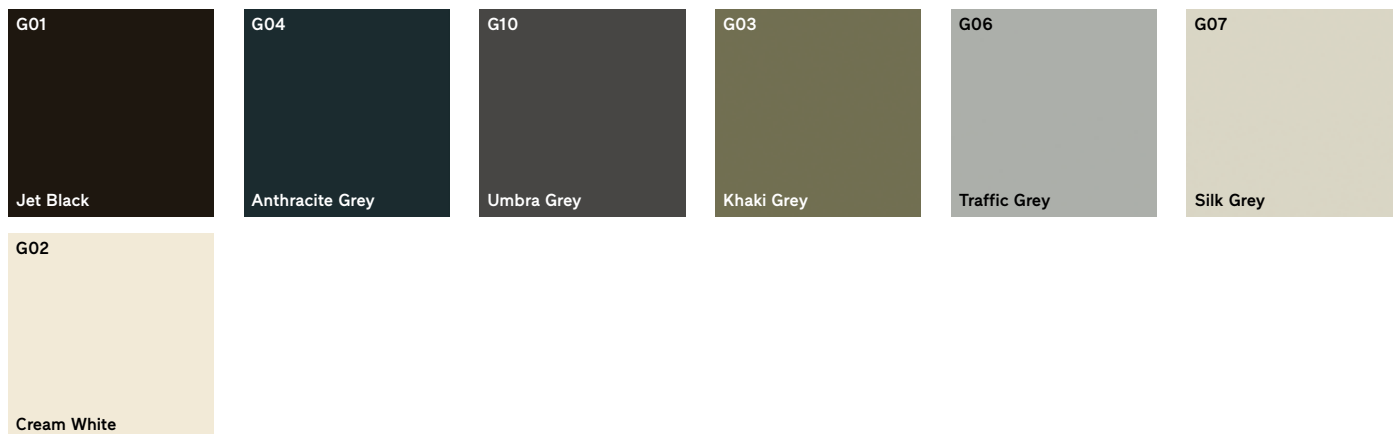

Colour representation similar.

Binding colour samples are available from your specialist consultant or at finstral.com/samples

Glass enamelled on the rear face, here in G03 Khaki Grey, G04 Anthracite Grey and G01 Jet Black, is produced by Finstral to the highest standards in its own factory.



Frame shape → Overview

From classically simple to minimalistically modern.

What should your window look like? As the window outline influences the style of your house more than any other component, the frames are custom-made by Finstral. And, thanks to its wide range of models, the company can always offer the right profile. Our wide variety of frame designs enables us to meet your aesthetic and functional requirements. Whether for new builds, old buildings or refurbishments .

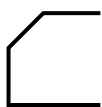

Sash outline Classic-line

Classic bevelled

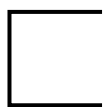

Sash outline Slim-line

Slim and angular

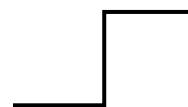

Sash outline Step-line

Stepped



Always slimline frames.

Whatever frame design you choose, Finstral window elevations always have narrower profiles than all its competitors. This is, of course, also true of the mullion, which has a

slender look even in the standard design. In combination with our highly translucent glazing, this ensures that plenty of daylight is admitted into your living spaces.

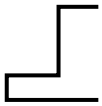

Sash outline Ferro-line

Industrial and distinctive



Sash outline Nova-line

All-glass look



Sash outline Nova-line Plus

Pared down to a minimum











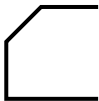

Frame shape → Classic-line

Classic bevelled.

This time-honoured frame shape is still one of our most popular sash options. Its features? Gently bevelled with the typically soft edges of uPVC. Available from Finstral in uPVC or with an aluminium facing on the exterior.

You can, of course, also design your Classic-line windows with matching glazing bars.

More information can be found under [Exterior → Design → Style elements](#)

Exterior material- Interior material	Sash outline	Mullion	Narrow mullion
			
Aluminium- Aluminium/wood/ Inlay	 24 mm	 146 mm	 127 mm
uPVC- uPVC	 31 mm	 146 mm	 127 mm
Aluminium- uPVC	 31 mm	 146 mm	 127 mm

FIN-Window Classic-line uPVC-uPVC, double-sash model, colour 45 White satin finish, aluminium windowsill in frame colour.













Frame shape → Slim-line

Slim and angular.

In elevation, our Slim-line sash frame features elegant, angular profiles that are ideal for creating a filigree, old-building look. These frames are among the narrowest on the market. The slimmer the frame, the bigger the glass area and the greater the amount of daylight flooding into your rooms. You can, of course, also design your Slim-line windows with matching glazing bars.

More information can be found under [Exterior → Design → Style elements](#)

Exterior material- Interior material	Sash outline 	Mullion	Narrow mullion
Aluminium- Aluminium/wood/ Inlay	 24 mm		 125 mm
uPVC- uPVC	 26 mm	 136 mm	 117 mm
Aluminium- uPVC	 26 mm	 136 mm	 117 mm

FIN-Project Slim-line aluminium-aluminium window, double-sash model, colour M800 Green Brown matt full-strength, aluminium windowsill in frame colour.



Frame shape → Slim-line Twin

Slender look, integral solar protection.

Thanks to its intelligent detailing, our Twin coupled sash assumes the same slender appearance as our other Slim-line models without coupled sashes. In terms of design quality, this clearly sets our system apart from the standard coupled windows on the market. With the interstitial Venetian blind or pleated blind, Slim-line Twin offers you flexible, integral, solar and privacy protection.

More information on the composition and functionality of the Twin coupled sash can be found under [Exterior → Protection → Sun/Heat → Shading in sash](#)

	Sash outline	Mullion
Exterior material- Interior material		
Aluminium- Aluminium/wood/ Inlay	 34 mm	 156 mm
uPVC- uPVC	 39 mm	 162 mm
Aluminium- uPVC	 39 mm	 162 mm

FIN-Window Slim-line Twin aluminium-uPVC, single-sash model, colour M716 Anthracite Grey matt full-strength, interstitial Venetian blind colour 0717 Silver-Coloured, aluminium windowsill in frame colour.



Frame shape → Slim-line sliding doors

A slender highlight.

Sliding doors are often the real eye-catcher of a property. Our window models with the Slim-line frame shape impress by the narrowness of their frames – even for large glass surfaces.



Exterior material-
Interior material

FIN-Slide
lift-and-slide door

FIN-Scroll
sliding door

FIN-Fold
folding door

Aluminium-
Aluminium/wood/
Inlay



65 mm



55 mm

uPVC-
uPVC



72 mm

Aluminium-
uPVC



65 mm



73 mm



FIN-Slide Slim-line lift-and-slide door aluminium-aluminium, colour F819 Grey Brown fine texture full-strength, with fixed light and flat threshold.











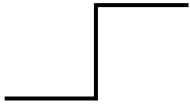

Frame shape → Step-line

Offset and stepped.

Do you want a simple yet striking profile? Our answer: Step-line. Here, the sash and frame are offset on the exterior to create a distinctive stepped design. The sash is reminiscent of traditional exterior window elevations. You can, of course, also design your Step-line windows with matching glazing bars.

More information can be found under [Exterior → Design → Style elements](#)

Exterior material- Interior material	Sash outline 	Mullion	Narrow mullion
Aluminium- Aluminium/wood/ Inlay	 24 mm		 127 mm
uPVC- uPVC	 31 mm	 146 mm	 127 mm
Aluminium- uPVC	 31 mm	 146 mm	 127 mm

FIN-Window Step-line uPVC-uPVC, single-sash model, colour 46 Silk Grey satin finish, aluminium windowsill in frame colour.



Frame shape → Step-line sliding doors

Narrow outlines.

Thanks to their high proportion of glass, sliding doors commonly add a special charm to the façade – while also providing ample daylight. Our lift-and-slide doors with the Step-line frame shape impress by their crisp lines and narrow frames.



Exterior material-
Interior material

FIN-Slide
lift-and-slide door

Aluminium-
Aluminium/wood

uPVC-
uPVC



83 mm

Aluminium-
uPVC



83 mm



FIN-Slide lift-and-slide door Step-line uPVC-uPVC, colour 01 White extra smooth, with fixed sash and flat threshold.





Frame shape → Ferro-line

Industrial and distinctive.

Frames with the aesthetic of classic steel windows: combining striking exterior outlines with filigree steel visuals, Ferro-line lends itself to both contemporary new builds and the refurbishment of old steel windows. What is it that characterises the industrial loft style of the sash? A face width of only 26 mm on the façade – together with a distinctively angled exterior outline. Matching steel glazing bars are, of course, also included in our range.

More information can be found under [Exterior → Design → Style elements](#)

Exterior material- Interior material	Sash outline	Narrow mullion
Aluminium- Aluminium/wood/ Inlay	 <p data-bbox="424 1541 480 1563">24 mm</p>	 <p data-bbox="1126 1541 1182 1563">127 mm</p>
uPVC- uPVC		
Aluminium- uPVC		

FIN-Project Ferro-line aluminium-aluminium window, single-sash model, colour M816 Mahogany Brown matt full-strength, with Ferro glazing bars and aluminium windowsill in frame colour.



Frame shape → Nova-line

Frame-covering all-glass look.

A large glass area with plenty of light? Our externally frameless Nova-line window sash meets this requirement while celebrating contemporary architecture. What's more: even combinations of movable window sashes and fixed lights always deliver a uniform aesthetic. Nova-line is the narrowest frame in its category on the market – and the ideal window for refurbishments for radically simplified window replacement with slide-in installation.

More information can be found under [Centre → Building connection → Mounting method for refurbishment → Window replacement with slide-in installation](#)

Always well proportioned.



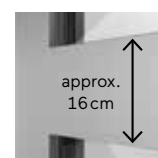

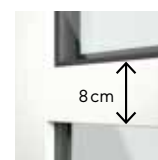

With Finstral windows, the transoms between fixed light and sash are practically as slender as the frames.



Standard market transoms



Slimline Finstral transoms

Exterior material- Interior material	Sash outline		Narrow mullion
Aluminium- Aluminium/wood		concealed	 78 mm
uPVC- uPVC		concealed	 82 mm
Aluminium- uPVC		concealed	 82 mm











FIN-Project Nova-line aluminium-aluminium window, single-sash model, colour M721 Black Grey matt full-strength, with fixed light and narrow transom in frame colour.



Frame shape → Nova-line Plus

Pared down to a minimum.

Frame-covering glass for minimalist architectural style? Our Nova-line Plus sash variant reduces the exterior outline to an absolute minimum, with the sash frame completely concealed behind the glass. This is achieved by enamelling the glass pane bonded to the sash frame at the edges of the rear face in one of seven colours of your choice.

Exterior material- Interior material	Sash outline	Narrow mullion	Glass-covered mullion
			
Aluminium- Aluminium/wood/ Inlay			
	concealed	78 mm	concealed
uPVC- uPVC			
	concealed	82 mm	concealed
Aluminium- uPVC			
	concealed	82 mm	concealed

FIN-Project Nova-line Plus aluminium-aluminium window, double-sash model, colour F722 Umbra Grey fine texture full-strength, enamel colour G01 Jet Black, with glass-covered mullion and aluminium windowsill in frame colour.





Frame shape → Nova-line Twin

Modern all-glass look with integrated solar protection.

The glass-covered Nova-line Plus sash model is also available in a Twin version. Thanks to its intelligent design, our coupled sash scores with unusually slim outlines. This makes it hardly distinguishable from the Nova-line variants designed without coupled sashes. With the interstitial Venetian blind or pleated blind, Nova-line Twin offers you flexible, integral, solar and privacy protection.

More information on the composition and functionality of the Twin coupled sash can be found under [Exterior → Protection → Sun/Heat → Shading in sash](#)

Exterior material- Interior material	Sash outline		Narrow mullion	Glass-covered mullion
				
Aluminium- Aluminium/wood/ Inlay				
	concealed			concealed
uPVC- uPVC				
	concealed		72 mm	concealed
Aluminium- uPVC				
	concealed		72 mm	concealed

FIN-Window Nova-line Twin aluminium-uPVC, single-sash model, colour M118 Zinc Yellow matt full-strength, enamel colour G01 Jet Black, with interstitial pleated blind in Light Grey colour and aluminium windowsill in frame colour.



Frame shape → Nova-line Plus sliding doors

Minimalist look with an abundance of glass.

The sliding elements in the Nova-line Plus design turn the dream of generous glazing with virtually invisible frame components into reality. A compelling statement for any space.



Exterior material-
Interior material

FIN-Slide
lift-and-slide door

FIN-Fold
folding door

Aluminium-
Aluminium/wood



concealed



concealed

uPVC-
uPVC

Aluminium-
uPVC



FIN-Slide Nova-line Plus aluminium-aluminium lift-and-slide door, colour F905 Jet Black fine texture full-strength, enamel colour G01 Jet Black, with glass-covered mullion and flat threshold.



Frame shape → Frame depth

Standard, thermally insulated or block frame.

In their standard versions, our frames have a construction depth of between 77 and 88 mm. The 90 mm deep model is designed to meet particularly high thermal insulation requirements. To cater for special regional construction contexts in the Netherlands, Belgium and the coastal regions of northern Germany and France, we offer the block frame with a construction depth of 124 mm.

Exterior material-
Interior material

Standard
Block frame 77+

Extra-insulating frames 90+

Block frame 124+

Aluminium-
Aluminium/wood/
Inlay



FIN-Project 78
Aluminium-Aluminium

uPVC-
uPVC



FIN-Window 77



FIN-Window 90



FIN-Window 124

Aluminium-
uPVC



FIN-Window 77+8



FIN-Window C 90+8
bevelled facing



FIN-Window N 90+8
angular facing



FIN-Window 124+3

→ Frame appearance

Visible or concealed.

With Finstral you have a choice: the frame can be installed on the exterior so as to remain visible or to be hidden in the reveal.

Traditional visible installation.

The traditional, exposed solution lends the frame a discreet appearance and is suitable for both contemporary new builds and old refurbished properties.



Frame visible after installation

Minimalist concealed installation.

Concealing the frame behind the masonry delivers a functionally efficient and aesthetically appealing solution for contemporary new builds.



Frame concealed after installation

Architecture is an interplay between proportion, form and material. And a pragmatic response to needs. And windows? They are an indispensable part of this dichotomy between functionality and aesthetics. Architect Perrine Ernest speaks about the key role of windows in the design of façades and buildings.

“Windows give form to entire buildings.”

What is the role of the window as an architectural design element?

Glass surfaces are of utmost importance in the design of the building envelope. In contrast to a solid wall, glass reflects – if you like – the absence of material. Windows give a rhythm to surfaces and convey a certain lightness. Windows are conceptually an important design element of the architectural language. They are the starting point for a whole series of geometrical games and help in composing the structure as a whole. Windows give façades their character and give form to entire buildings.

As an architect, what are the aesthetic criteria that you use when selecting windows?

That depends on the particular building and is a function of the architectural style and the specific requirements. The overall result must be harmonious. What is observable at the moment is a tendency to “delete” window frames. Profiles are becoming ever thinner and slimmer and thus almost invisible. From an aesthetic point of view, however, it can be just as interesting to emphasise the frames and consciously provide accents. For example, you can mark window sashes or highlight them by changing the material.



Maximum design freedom:
Perrine Ernest, partner at Belgian architectural practice Specimen, champions modularity and a maximum of variety for window design.



Folded façade: With KIETUDE in Namur, Belgium, architectural practice Specimen in 2018 crafted an energy-efficient residential building with a diversity of outward views.

To what extent do the modularity and materiality of windows influence the architecture?

Put simply: our freedom to design increases with the freedom of form. A large selection of modular, combinable materials, colours and textures infinitely extends our possibilities. And it is the same for details. From the colour of the glazing beads to the spacers between the panes, the texture of the glazing, its reflection ... everything can be individually designed.

But it is always about orchestrating the inside and the outside ...

Yes, for example, windows can frame views or play with perspectives. Large glass surfaces in particular can blur the boundaries between the interior and exterior and create a special spatial effect. Even small rooms can be opened up with cleverly positioned windows and thus acquire a certain expansiveness. Light gives form to spaces.

How important are windows for well-being and living quality?

Infinitely important. Windows provide us with light – and we cannot live without light. In addition to indirect natural light, it is also possible to bring direct sunlight into the building through purposeful window design. The resulting play of light and shade in the space changes in the course of the day and enhances the feeling of well-being.

What design trends do you see and what direction are developments taking?

The present is dominated by the question of energy efficiency. Architecture makes an important contribution to sustainability, which can also be seen through the design. The challenge is to keep the energy footprint of buildings as low as possible and to further develop the architectural formal language.

How can this be achieved?

On the one hand, by selecting recyclable materials that are manufactured in a way that minimises harm to the environment. On the other, by producing intelligent building envelopes that not only provide excellent insulation but also, for example, use passive solar energy. But sustainability can also mean developing flexible buildings that change with the demands of use. This way we can avoid having to carry out alterations.

What role does sustainability play when selecting a product?

Nowadays, issues of durability and sustainability are fundamental to the choice of building components. Other criteria, such as price and technical specifications etc., are also important, but, for the building envelope, longevity and sustainability are decisive.

Frame shape → Types and configuration

Maximum design freedom.

Windows allow numerous possible configurations of opening and fixed lights, and determine the aesthetic impact of the façade. They influence comfort, e.g. through narrow, easily operated sashes that do not overly protrude into the room when open. At Finstral, you can choose from a wide range of options. Here is a selection of popular designs.

Single-sash

Examples



Sash with frame (type 101)



Frameless sash (type 101)

Double-sash

Examples



Fixed mullion (type 201)



Flying mullion (type 401)



Glass-covered mullion (type 401)

Multi-sash

Examples



Two opening sashes, one fixed light in centre (type 302)



Three opening sashes with flying mullion (type 421)



Fanlight as bottom-hung sash with double-sash window and flying mullion (type 404)



Fanlight as frameless bottom-hung sash with frameless, double-sash window and fixed mullion (type 404)



Fanlight as fixed light with frameless double-sash window and glass-covered mullion (type 404)

Fanlight
Examples



Sublight as fixed light with single-sash window (type 207)



Sublight as fixed light with frameless single-sash window (type 207)



Sublight as fixed light with frameless, double-sash window and glass-covered mullion (type 402)

Sublight
Examples

Frame shape

→ Ribbon window/window combinations

With a sense of rhythm and proportion.

For ribbon windows or other multi-part combinations, Finstral offers a wide range of design options that are adaptable to varying project-specific circumstances or aesthetic demands. Here is a selection of popular combinations.

Ribbon windows

Examples



Ribbon of three coupled windows: one window with Slim-line sash (type 101) and two fixed lights (type 102)



Ribbon of three coupled windows: one window with Nova-line sash (type 101) and two fixed lights (type 102)



Ribbon of three windows with one Slim-line sash and two fixed lights (type 324)



Ribbon of three windows with one Nova-line sash and two fixed lights (type 324)



Three-part window wall with frameless sash and fixed lights at side and bottom



Traditional balcony door combination comprising coupled window with sash (type 101) and fixed light (type 102)

Window combinations
Examples



Six-part window wall with three frameless sashes at top and three fixed lights at bottom



Ribbon of four windows with variable corner couplings (90°-180° possible)

Frame shape

→ Angled and arched windows

Pointed or round?

You may be responding to project-specific circumstances or adding a focal point to the architecture. A wide range of special shapes is possible – in both uPVC and aluminium. The feasibility of the design depends on the material composition. Here is a selection.

Angled shapes

Examples



Triangle



Quadrilateral



Pentagon



With division



Without right angle

Round shapes

Examples



Round arch



Segmental arch



Quarter arch



Circle

FIN-Project Nova-line aluminium-aluminium segmental-arch window, single-sash model, colour 2525 Mars special effect colour.



Frame shape → Window wall

Large glass surfaces. Wide variety.

More than simple fixed glazing, though without being a complex façade solution: our window wall system offers ever-generous panoramas. High-grade components, intelligent detailing, custom design, the high level of factory prefabrication and properly tested building connections make the FIN-Vista window wall an attractive alternative to conventionally designed stick (mullion/transom) systems.

More information on the installation of FIN-Vista can be found under [Centre → Building connection → Mounting method → Window wall](#)

Structurally optimised.

Steel-reinforced mullions

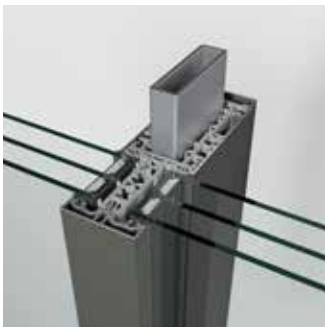

Narrow faces.

Only 5 cm mullion width

Combinable with all opening types in range.

Depending on your needs, our glass walls can accommodate windows, casement doors, front doors, sliding doors, and folding doors.

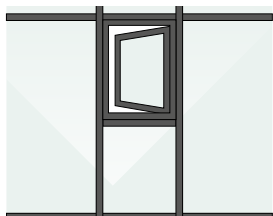

Window

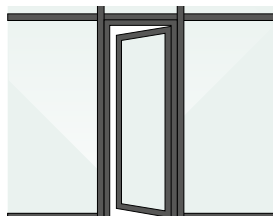

Casement door

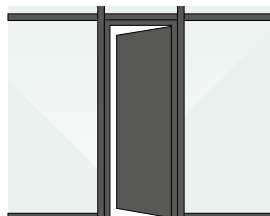

Front door



FIN-Scroll



FIN-Slide

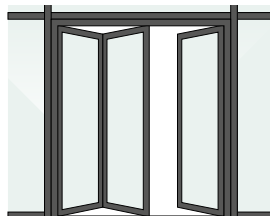

FIN-Fold

FIN-Vista Slim-line aluminium-aluminium window wall, colour 2525 Mars special effect colour, with one horizontal and one vertical division plus built-in FIN-Project Nova-line Aluminium-Aluminium casement door.



Frame shape

→ Window wall combinations

Custom design with glass.

The modular FIN-Vista system is our answer to the trend towards generous glass surfaces. In most cases, glass walls are not required to extend over several storeys. Nor does their self-supporting length or width normally exceed five metres. The fixed lights, window sashes or sliding door sashes are installed in a grid of vertical mullions and horizontal transoms.

Classic.



Window wall with six lights

All-glass vertical.



1, 2a, 3

Window wall with six lights, with glass-covered transoms and plinth plus concealed frame



Standard mullion and transom



Standard mullion and plinth profile



2a

Standard mullion, glass-covered transom

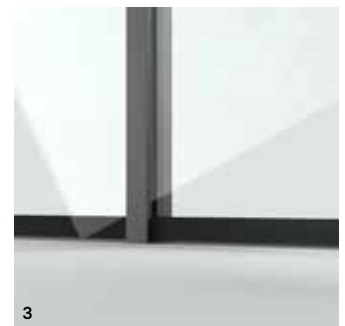

3

Standard mullion, glass-covered Nova plinth profile

All-glass horizontal.



1, 2b

Window wall with six lights, with glass-covered mullions and concealed frame: glass-covered plinth not possible in this case as lights must always be supported on two sides.



2b

Glass-covered mullion, standard transom



Glass-covered mullion, standard plinth

All-glass options.

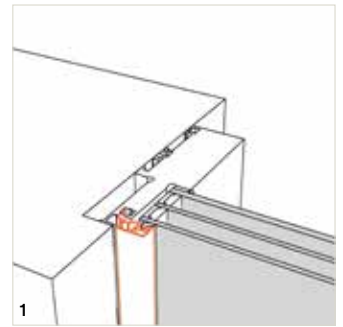

1

Minimum frame visibility

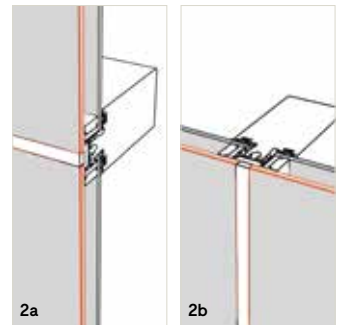

2a

2b

Glass meets glass

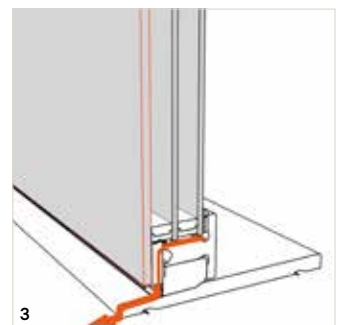

3

Glass-covered plinth, concealed drainage

Frame shape → Window wall corner solutions

A wealth of options, a wealth of glass.

The modular FIN-Vista system provides for a host of possible combinations: from designs maximising the proportion of glass to corner solutions.

Classic.



Window wall incorporating casement door plus three fixed lights and a corner coupling (90°-180° possible)

More glass.



Window wall incorporating casement door plus three fixed lights and a glass corner (90°-150° possible), faced on the exterior with an aluminium angle



Standard corner coupling, exterior



Standard corner coupling, interior



Corner coupling with glass corner, exterior



Corner coupling with glass corner, interior

All glass.



Window wall incorporating frameless casement door, three fixed lights with glass-covered mullion plus an all-glass corner (90°), faced on the interior with an aluminium angle



Corner coupling with all-glass corner, exterior



Corner coupling with all-glass corner, interior

All-glass options.

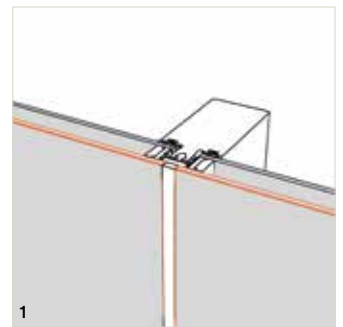

Glass meets glass

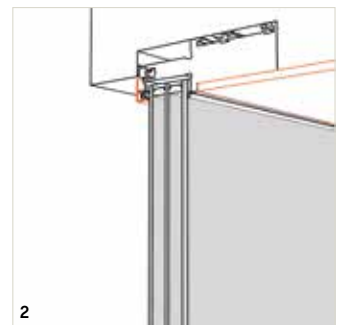

Frameless installation on interior

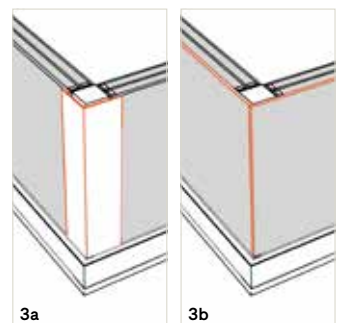

With glass around corner

Style elements → Infill panels

Always in character with the overall building composition.

All Finstral infill panels offer good thermal insulation, achieving top values of U_p 0.6 W/m²K.

More information can be found under [Centre → Insulation → Heat/Cold](#)

Extra-high noise protection of up to 42 dB is achievable with our sound-insulated models.

More information can be found under [Centre → Insulation → Noise](#)

To meet enhanced security requirements, infill panels with special security features are also available.

More information can be found under [Exterior → Protection → Burglary](#)

Smooth infill panels.

uPVC

42

White
embossed

Aluminium

658

Green

Enamelled glass

G03

Khaki Grey

Patterned glass

48

Matt glass
White

Ceramics

C04

Oxide
Nero

Infill panels with relief.

uPVC or aluminium, flattened



Classic



Style

with rounded
recess

uPVC or aluminium, grooved

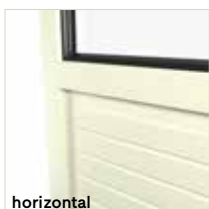

horizontal



vertical



diagonal

FIN-Project Nova-line aluminium-aluminium window, single-sash model, colour F716 Anthracite Grey fine texture full-strength, with narrow transom in frame and smooth infill panel.



FIN-Window Slim-line aluminium-uPVC casement door, double-sash model, colour F45 White satin finish fine texture full-strength, with flattened infill panel, attached Classic glazing bar and glass-dividing sash bar.



Style elements → Glazing bars

To create the typical look of an old building.

Glazing bars give windows structure and rhythm and lend them the traditional look of an old building. Whether attached or interstitial: you can always customise your design to suit the window.

Attached glazing bars.

Attached glazing bars are always combined with spacers in the glass to produce an even more authentic look. You can choose between the Classic, Style and Ferro design variants.



Rectangular wide: Classic 63 mm
250+ aluminium colours



Rectangular: Classic 33 mm
all uPVC and 250+ aluminium
colours



Rounded: Style 33 mm
all uPVC and 250+ aluminium
colours



Steel window look: Ferro 33 mm
250+ aluminium colours

Interstitial glazing bars.

Interstitial glazing bars are inserted in the gap between the panes. They lend the window the traditional glazing bar look while being much easier to clean.



Filigree: 9 mm
White, brass colour



Narrow: 18 mm
250+ aluminium
colours



Distinctive: 26 mm
250+ aluminium
colours

Special shapes.

Glazing bars can also be used to accentuate custom-designed window shapes.



Decorative elements.

Add a stylish touch to refurbishment projects.



FIN-Window Slim-line aluminium-uPVC window and casement door, double-sash model, colour 358 Gris special effect colour, with attached Classic glazing bar.



Style elements

→ Plinth profiles

Design element for your casement door.

At the junction with the floor, casement doors can be designed with a continuous frame or a threshold. You also have the option of incorporating up to five plinth profiles or an infill panel in the sash frame as a visual barrier.

Nova-line

Classic-line

Classic-line
with three plinth
profiles at bottom
(1 to 5 are possible)Classic-line
with transom and
infill panelClassic-line
with sidepanelCasement door with
flat thresholdStandard casement
door

Only for uPVC-uPVC and
aluminium-uPVC

Sidepanel with and with-
out plinth profile

→ Exterior windowsill

Always a match for your window.

Exterior windowsills add an aesthetic note to your façade while protecting it from weather-induced soiling. Finstral windowsills are always made of aluminium, making them highly scratch- and fracture-resistant, easy to clean and resistant to heat, cold, sun and rain. With the choice of some 250 colours, we offer you maximum design variety.

Traditional installation.

With the traditional installation without mounting frame, the bottom part of the assembly is slightly higher.



Two-stage installation.

A more elegant look: use of the FIN-Fix mounting frame for installation delivers a uniform frame appearance around the full perimeter.



More information on the use of mounting frames can be found under [Centre → Building connection → Mounting method for new build/refurbishment → Two-stage installation with mounting frame](#)

Exterior → Protection
Keeping out
what shouldn't get in.

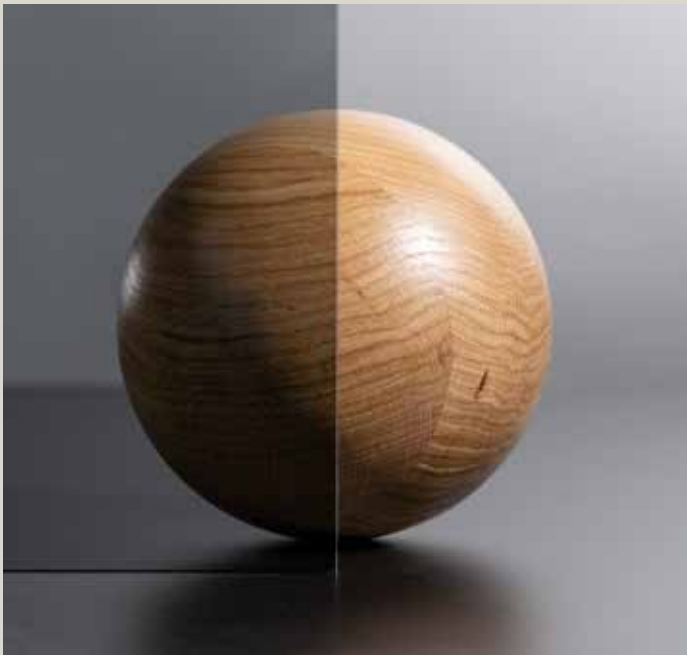

Burglary
Sun/Heat
Privacy
Insects



Burglary

Burglary protection is necessary and effective.

Burglars prefer to enter via windows. Why? Because it's quick: It takes just ten seconds to prise open a poorly secured window with a screwdriver. Police statistics show that, if burglars are unable to break into a house within two to five minutes, they will give up. More than two-thirds of all burglaries can be prevented by means of modern security fittings.

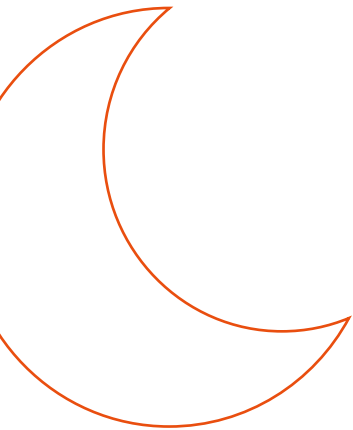

Twilight preferred.

Most break-ins into single-family houses occur between 4 pm and 8 pm, and into apartment buildings between 12 pm and 8 pm. Burglars also prefer the dark season, i.e. from November to March.¹



The most common tools.

In connection with burglaries, we often think of crowbars or the like, but such tools are actually seldom used. Most burglars use simple screwdrivers, hammers or wedges.

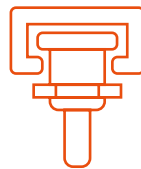

Always maximum security: Finstral windows.

In the locked position, the roller mushroom head bolt prevents upward, downward, outward and inward movement. This is due to the claw action when engaging with the security locking part.



Every fifth person moves out.

Having your home broken into is always a psychological burden. 20.3% of those affected subsequently move home. This is the conclusion drawn from a survey on the psychological consequences of burglary victims in Germany.²

Preferred entry routes.

Apartment building



Single-family house

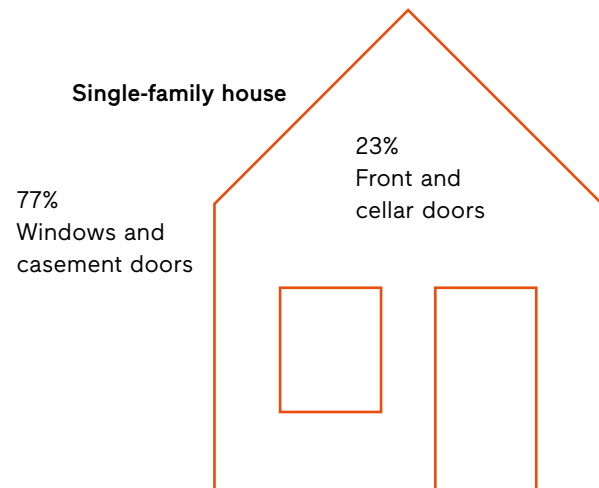

Apartment doors must also be secure.

Burglars normally seek entry to apartment buildings from the front side. Particularly at risk here are windows, casement doors and the doors to the ground-floor apartments.³



Windows as a weak point? Not with us!

Statistics show that the most common way to break in is via windows or casement doors. Even the standard version of Finstral windows can offer a high degree of protection against burglary.



“Our guiding principle for burglary protection: mechanical trumps electronic.”

Ralf Trippe, First Chief Superintendent and Head of the Cologne Criminal Investigation Department Crime Prevention/Victim Protection, which also publishes the Cologne study, relevant to burglary protection throughout Europe.



10 to 50 seconds.

That's how quickly burglars can prise open windows and casement doors with normal locking bolts. Although most break-ins are via ground-floor windows, others can easily be reached by climbing onto garages and carports. Experts thus recommend that such windows are also adequately secured.

Source:

¹ 2017 Cologne Study

² Statista/Criminological Research Institute of Lower Saxony (KFN)

³ 2017 Cologne Study

Whether burglars have an easy time above all depends on how well a window is secured. Which is why, for test purposes, the Institut für Fenstertechnik (ift) Rosenheim regularly carries out mock burglaries on windows and doors. Security expert Dipl.-Ing. Robert Krippahl explains what exactly happens during these tests and what construction clients should look out for when choosing their windows.

“We go about it like burglars.”

What is the procedure for performing burglary tests on windows?

We go about it like burglars. Our test methods simulate the way they work and are regularly updated and aligned with the practical experience gained by the criminal investigation department. As most break-ins involve prising open the window, the key element in a burglary test is the manual part. Using various burglary tools, we attempt to create a passable opening through which a burglar can enter.

How do you determine whether a window is burglar-resistant?

The decisive test criterion is the break-in time: upon encountering sufficient mechanical resistance, burglars behave like a deer: they get nervous. Without speedy success, they tend to abort the operation. According to police statistics, 40% of attempted break-ins can be prevented in this way. The resistance time ranges from 3 minutes (RC 2) to 20 minutes (RC 6). If no passable opening is created within the test period, then the test is deemed to have been passed.

So most burglars prise open windows. Is security glazing still needed at all?

Burglar-resistant building components are only ever as strong as the weakest link in the overall “security chain”. This chain extends from the masonry, fixing, window frame and hardware, including screw connections, to the glass infill panel and its integration. The ift engineers check all possi-

ble weak points. To prevent glazing from being breached, say, by the simple throw of a stone, standards-compliant smash-resistant glazing is required for resistance class RC 2 upwards. For the higher resistance classes, the demands placed on the glazing naturally increase.



He gives burglars a hard time: Dipl.-Ing. Robert Krippahl is Product Manager at ift Rosenheim. Prior to that, he spent many years working as the manager of a test institute in a security lab, which also assessed burglar resistance.



The burglar resistance of windows is investigated at a test stand at the Institut für Fenstertechnik (ift) Rosenheim.

So is resistance class RC 2 adequate and when is RC 3 recommended?

First of all, the risk of burglary needs to be assessed and the appropriate security fittings defined. In other words: the less visible a window is from the outside, the greater the distance to the next-door neighbour and the more valuable a property appears or is, the greater the risk of burglary. Alongside deterrents such as movement detectors with light and acoustic signals, the mechanical security of windows and doors is the most important precaution. The required fittings also depend on the particular security needs of the building occupants. For normal residential buildings without valuable inventory, the criminal investigation department recommends resistance class RC 2. RC 3 applies for properties containing valuable assets as well as endangered office and administrative buildings.

What points do I need to consider when selecting new windows?

It is important that the windows and casement doors have successfully passed a full test to European standard series EN 1627 ff. At ift Rosenheim, this is confirmed by a test document with the corresponding ift certificate.

Does the installation process also play a role?

It certainly does. Good-practice installation is a key element of the security concept. Fitting only by qualified installers is strongly recommended. To achieve maximum security,

construction clients should specify certified products and services for windows and their installation.

And how can I establish whether the windows of an existing apartment or older house offer adequate burglary protection?

Mushroom-type or similar bolted locking points are a clear indication of burglar-resistant windows. Security glazing is not always marked as such and is often difficult for laypersons to recognise. A certified specialist company should be consulted on such matters.

About ift Rosenheim

ift Rosenheim is a Europe-wide notified research, testing, monitoring and certification body and is internationally accredited under DIN EN ISO/IEC 17025. Its remit includes the testing and assessment of all the properties of windows, façades, doors, gates, glass and construction materials as well as personal protective equipment.

Burglary → Security standards

All-round security.

With Finstral you are always on the safe side. Thanks to everything from the robust frame construction and high-grade security hardware with roller mushroom head bolts to the sash frames, which are always securely bonded. Even our base models meet the highest standards.



Roller mushroom head bolts.

Unsecured windows with normal pin bolts can be prised open in ten seconds. Security fittings, such as our hardened steel roller mushroom head bolts, can prevent this. The mushroom head on the sash hooks tightly into the recess of the solid locking part on the frame and further secures the window, thus making it almost impossible to prise open.

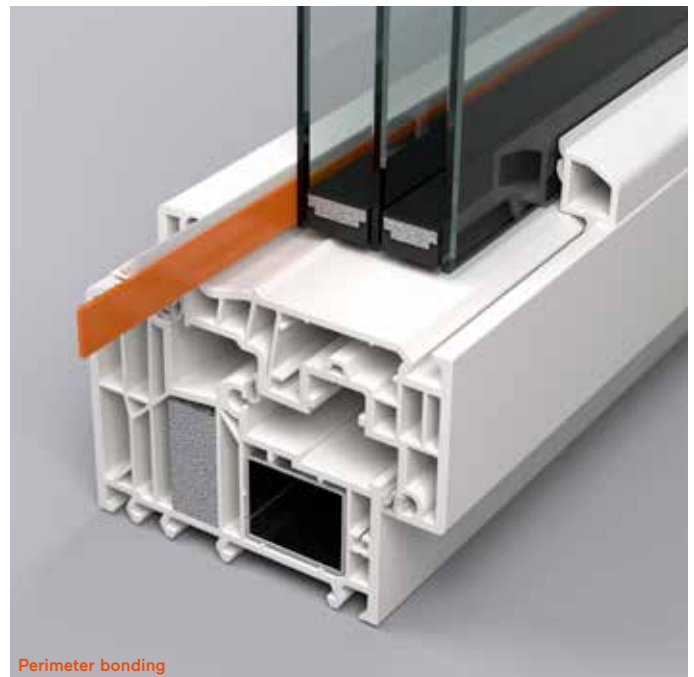

Bonded panes.

Traditional solutions use glazing blocks to clamp the glass into the sash frame. This automatically permits a certain amount of movement in the frame when levered with a burglary tool. At Finstral, the panes – for both windows and lift-and-slide doors – are always bonded in the frame around its full perimeter such that glass and frame become a single, solidly connected, rigid unit that is much harder to prise open.



Hardware behind middle gasket

Middle gasket.

Window frames with a middle gasket make it harder for burglary tools to reach the hardware from the outside. As Finstral windows always have a middle gasket, they offer greater burglar resistance than frames fitted only with a simple weatherstrip.



Locking points

Four-point security locking or more.

In the FIN-Window system, windows and doors are always fitted as standard with solid security locking points and roller mushroom head bolts at four positions. FIN-Project is even equipped as standard with perimeter security hardware with a maximum lock spacing of 85 cm. On request, we can supply RC 2- or even RC 3-certified security fittings.

Burglary

→ Security options for windows and lift-and-slide doors

Extra security.

Lockable handles, safety glass and window sensors: for maximum burglar resistance, you can fit your windows and lift-and-slide doors with additional security features.



Lockable handles.

Push-button handles and handles with a keyed lock prevent any displacement of the hardware. The roller mushroom head bolt cannot be disengaged from its locking part when levered. The handle cannot be moved and the window cannot be opened. In line with RC 2 requirements, the lockable handle can withstand a force of 100 Nm.

More information can be found under [Interior → Design → Handles/Hinges](#)



Laminated safety glass.

Multiprotect consists of two glass panes bonded together with a highly tear-resistant film. This makes it difficult to break through the glass, binds together glass splinters and prevents injury. It is available in three resistance classes: P2A, P4A, P5A.

Apart from its burglar-resistant effect, Multiprotect offers further benefits: [Interior → Operation → Safety in use, Centre → Insulation → Noise, Exterior → Protection → Sun/Heat](#)



Window sensor.

Concealed magnetic sensors tell the alarm system whether the windows are open, tilted or closed. The monitoring sensor also serves to control heating and air conditioning systems. Also available with VdS (German Association of Property Insurers) classification.



Drill protection.

Combinable with any handle, the hardened-steel drill protection is located directly in front of the handle mechanism and prevents the sash from being drilled through from the outside. This makes it impossible for burglars to access the window's locking mechanism.



Locking cylinder.

With a standard cylinder lockable on both sides, you can lock and unlock your balcony door from the outside and the inside, even if a key is inserted on the other side. Security level 1 and 2 cylinders offer improved drill or drill/pull protection and are supplied with a security card for ordering replacement keys.



Vent ventilation sash.

Our ventilation sash can be opened or closed as required while remaining hidden on the outside by slats and insect screens. It is therefore impossible to tell when it is open. Moreover, Vent can be produced in such a narrow size as to rule out any intrusion by burglars.

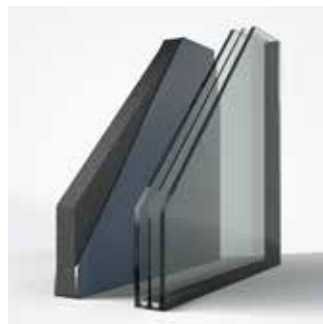

Security infill panels.

You also have the option of fitting infill panels with special security features in your window or lift-and-slide door. Finstral offers a selection of security infill panels up to class P5A.

Burglary

→ Security options for windows

For maximum protection.

If you would like to make your windows particularly burglar-resistant, then you can choose from the following options.



Perimeter security hardware and corner hinge.

FIN-Window windows, which are fitted as standard with four security points, are also available with security locking around the full perimeter. As an added option, an extra securing point at the corner hinge and stronger screw connections for the locking parts provide even greater security.



RC 3 security fittings.

With reinforced facings, P5A safety glass, additional screw connections and reinforcement of hardware and locks, our FIN-Project windows are able to meet resistance class RC 3 requirements.



Anti-lift device.

The solid anti-lift device prevents the sash from being lifted up when an attempt is made to lever it open.

→ Security options for lift-and-slide doors

Maximum security.

Optional security fittings are also available for your lift-and-slide doors to ensure that even large openings are adequately protected against burglary.



Additional locking points.

For enhanced burglary protection, our lift-and-slide doors can be fitted with additional locking points above the handle and at the threshold. This security option also includes drill protection for the handle.



Secure trickle ventilation.

For secure ventilation, our lift-and-slide doors can be provided with a locked trickle ventilation position.

Burglary

→ Security sliding and folding doors

Secure sliding and folding.

Our windows and doors with sliding, parallel sliding and folding opening actions likewise offer good burglary protection. The standard security features and optional extras are shown in the overview.

Parallel sliding-tilting window and door

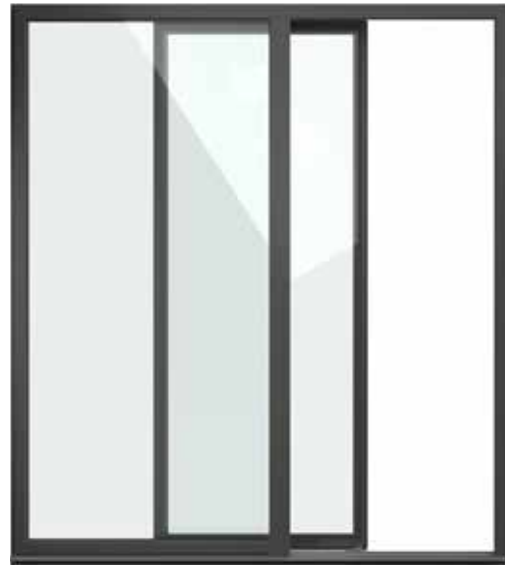

Standard

- Bonded sashes
- Middle gasket
- Multi-point locking with 4 mushroom head bolts

Optional

- Multiprotect laminated safety glass
- Lockable handle
- Drill protection
- Perimeter security locking
- Magnetic contact
- Security infill panels

FIN-Scroll sliding window and door



- Bonded sashes

- Multiprotect laminated safety glass
- Lockable handle
- Anti-lift device
- Magnetic contact

FIN-Fold folding door



- Bonded sashes
- Multi-point locking with up to 3 mushroom head bolts

- Multiprotect laminated safety glass
- Magnetic contact

Burglary

→ Certified security

All requirements met and many certified.

Finstral windows inherently offer an unusually high standard of burglary protection. Many window types have also been laboratory tested under real-life conditions to RC 2 specifications. Although all models meet RC 2 requirements, our enormous range of products means that only the most popular ones have been tested and issued with a certificate.

What is RC 2?

RC 2 stands for Resistance Class 2. Under EN 1627, it represents one of the seven classes for the resistance of windows and doors to attempted burglary. RC 2 windows can withstand an attempted break-in by an occasional criminal using physical force and simple tools, e.g. screwdriver, pliers and wedges, for a continuous period of at least three minutes.

RC 2 requirements:

- It must be impossible to prise away locked hardware, e.g. due to a perimeter mushroom head bolt hardware
- It must be impossible to tamper with the locking mechanism via the window handles, e.g. due to lockable window handles
- It must be impossible to break out the window's infill panels and panes of the window, e.g. due to class P4A infill panels

Finstral offers all the technical features needed to meet the requirements for RC 2 certification. Though not required by RC 2, all Finstral windows are provided as standard with additional burglar-resistant design features, e.g. a middle gasket and bonded panes. Other security fittings are optionally available.

More information can be found under: [Exterior → Protection → Burglary → Security options](#)

What is RC 3?

Windows with burglary resistance class RC 3 can withstand an attempted break-in by an occasional criminal using physical force and additional tools, e.g. a second screwdriver and a crowbar, for a continuous period of at least five minutes.

RC 3 requirements:

- It must be impossible to prise away locked hardware, e.g. due to a perimeter mushroom head bolt hardware
- It must be impossible to tamper with the locking mechanism via the window handles, e.g. due to lockable window handles
- It must be impossible to break out the window's infill panels and panes of the window, e.g. due to class P5A infill panels

What are P4A and P5A?

Security infill panels and glazing are tested for their smash and burglar resistance. For class P4A, a 110 × 90 cm component must withstand the three-fold (for P5A: nine-fold) impact of a 4.11 kg steel ball with a 10 cm diameter from a height of 9 m. The film thickness is 1.52 mm for resistance class P4A and 2.28 mm for class P5A.

What is VdS?

VdS (German Association of Property Insurers) approval is a quality label for security products. It testifies to the functional and operational reliability of intruder alarm, CCTV surveillance and access control systems, of safes, high-security locks and the like. The greater the risks, the higher the resistance level and corresponding VdS security classification should be. Our magnetic contact is optionally available with Class B VdS approval.

→ Security packages

If you want to meet RC 2 or RC 3 requirements.

Finstral fits all windows as standard with at least four security locking points and roller mushroom head bolts so as to make it more difficult to prise them open. On request, we also offer RC 2- and RC 3-certified security fittings for selected sash models of windows and lift-and-slide doors.

Security package for RC 2

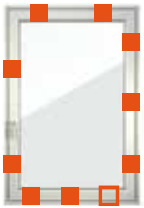

Multi-point security hardware



Lockable handle



Drill protection



Secured glass fixing

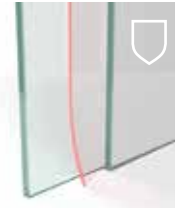

Laminated safety glass P4A

Availability:

FIN-Window

Classic-line, Slim-line, Step-line, Nova-line, Nova-line Plus for single- and double-sash models within range of minimum and maximum sizes

FIN-Project

Classic-line, Slim-line, Ferro-line, Nova-line, Nova-line Twin for single-sash model within range of minimum and maximum sizes

FIN-Slide

Step-line Door for single-sash model within range of minimum and maximum sizes

Security package for RC 3



Multiple additional safeguards around perimeter



Lockable handle



Drill protection



All-point security locking



Anti-lift device



Laminated safety glass P5A

Availability:

FIN-Project

Nova-line Plus with special steel-reinforced external facing for frame

Sun/Heat

Ample light, pleasant temperatures.

Wouldn't everyone like large windows that admit maximum daylight and adequate warmth into the interior? Though only enough for comfort. With warmer summers and longer periods of sunshine, glare and heat protection are becoming ever more important. With narrow frames and glazing that maximise light transmission, Finstral ensures that as much daylight as possible can enter the interior. And, to combat glare and prevent interior overheating, we offer effective solutions with solar protection glass and sunshading. This enables you to tailor your windows to the requirements of your regional location, orientation, building efficiency and architecture.



90%
of our time is spent in enclosed spaces. Experts recommend 30 minutes' daily exercise in daylight – even when the sky is overcast.¹



Light keeps us healthy.

Light has a stimulating effect. It activates and boosts our motivation. Without light, we fall ill – not only mentally, but also physically. Light has an important physiological function: it “sets” our “internal clock”. This, in turn, controls the timing of and coordinates all important processes in the body. Inadequate light throws our internal clock out of sync, which affects our energy levels and can make us ill.

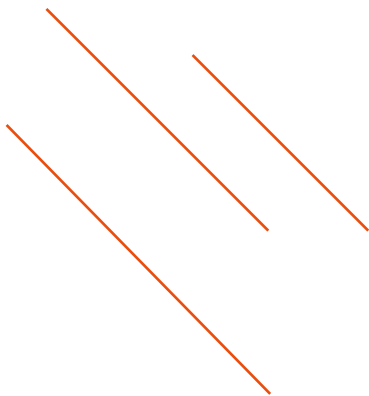

How much brightness from outside does an interior need?

According to the European daylighting standard, interiors should achieve 300 lux over 50% and at least 100 lux over 95% of their floor area. This is feasible with a window area equivalent to 20 to 25 % of the room's floor area. Leading lighting experts go further and recommend 5-10 % of external brightness for interiors. By comparison, approx. 5,000 lux is measured outdoors even on dull November days and over 60,000 lux on sunny days.

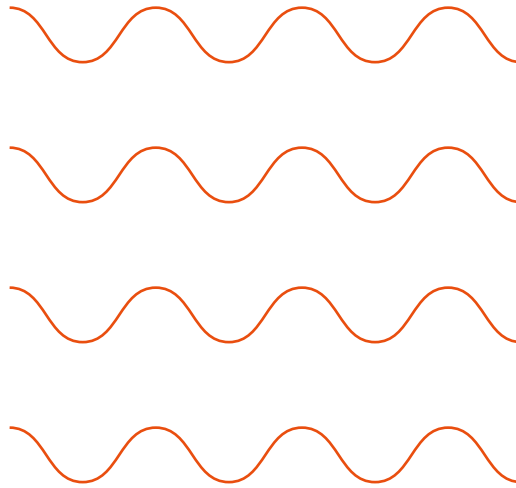

What exactly is daylight?

Daylight is the visible part of solar radiation. Though perceived as a single colour, it comprises a range of colour components that become visible when the light is refracted through a prism. Daylight changes in brightness, direction and colour in function of the time of day, season, cloud cover and geographical location.

Solar gain.

For a long time, windows represented the energy-efficiency weak points of buildings. Nowadays, state-of-the-art window systems help to generate energy by using sunlight as a heat source, even when it is cold outside. According to studies, larger windows, in particular, reduce heating demand. The correct choice of glazing also plays a role: here, Finstral offers triple glazing with a high-efficiency coating that makes it the most modern on the market. For unbeatable insulation performance and the maximum possible solar energy gain.

More information can be found under
[Centre → Insulation → Heat/Cold](#)

Narrow frames mean more light ...

Even when frames are only 2 to 3 cm slimmer, the glass area becomes noticeably larger and admits more light.



Standard market windows
Total frame width approx. 13 cm



+14 % glass area with
FIN-Window Slim-line
Total frame width approx. 10 mm



+28 % glass area with
FIN-Window Nova-line
Total frame width approx. 7 cm



... and better glass

Standard triple glazing absorbs 1/3 of daylight, with Finstral only around 1/4. We install only triple glazing with a maximum possible light transmission of 80 %.

Sample calculation for
100 × 145 cm window

Source:

¹ YouGov "Indoor generation" study, 2018



Prof. Peter Andres has been head of lighting design practice ANDRES + PARTNER since 1986. With his team in Hamburg and Tyrol, he seeks to make light perceptible and tangible. He teaches natural and artificial lighting design at the Peter Behrens School of Arts in Düsseldorf.

What does a room need to make us feel comfortable? As much natural light as possible. Studies have shown that the brighter a room, the more positively we rate it. Which, according to lighting designer Professor Peter Andres, is hardly surprising given that we humans are creatures of the light. Here he explains why daylight cannot be replaced by anything else and what to look for when choosing windows so as to minimise light loss on new-build and refurbishment projects.

“Daylight is a basic nutritional requirement.”

Is there such a thing as an optimum window area per room?

No, we lighting designers calculate this differently. In our latitudes we recommend five to ten percent of the external brightness for living or communal areas. This suffices to make the room bright and there are no problems with light in the dark months of the year. The architect and lighting designer have to make specific decisions depending on location and adjoining development on how to achieve this five to ten percent. Bigger windows may be needed if a neighbouring house is too close. A wide open site is, of course, a different proposition. That is why there is no optimum window area per room.

How important is the layout of windows in the room?

It is very important. Just one example: a fanlight admits up to three times as much light into the interior as an identically sized sidelight. If – as with refurbishments – we want to optimise the use of existing window areas, the top edge of the window becomes a focus of attention: if that can be raised by 10 cm, then disproportionately more light will enter the room. Should that not be feasible, we have to specify narrow frames and good-quality glass to minimise the light lost by refurbishment.

Why is it so important to get as much light as possible into the interior?

Light is a basic nutritional requirement. Without light we humans would not exist. We are creatures of the light. It starts first thing in the morning: we need a certain amount of brightness just to wake up. Only when light strikes the eyes does the brain release a positive stress hormone that suppresses the sleep hormone melatonin and makes us active. In the past, people tended to spend much more time outdoors while today we have to spend most of our time indoors for work. We are not designed for that. The development of all our bodily functions over the course of evolution has been geared to natural light.

And now, in the last nanoseconds of evolution, we are attempting to create a similar effect using artificial light sources. That cannot work. Nothing can replace daylight.

Can a lack of light be harmful to our health?

Yes, our whole body system becomes confused if we get too little daylight. Sleep disorders, vitamin D deficiency or depressive moods are not uncommon. Unfortunately, we have no sensation of pain to signal a lack of light.

And not everyone has a workplace directly by the window. What is more, light quality often suffers from the poor quality of the window glass. In other words, the light it admits into the room is not as natural as it should be. So we try to com-

pensate for this deficit with artificial light. But this prevents our body from keeping in sync with the time of day or year. Although it is bright enough to work, there is an inadequate amount of natural light.

You mentioned light quality ...

Yes, some types of window glass do reduce the quality of the light by cutting off energy in the short- and long-wavelength spectrum at the transition between visible and invisible light. We now know that adequate light in the long-wavelength infrared range will prevent age-related macular degeneration. Short-wavelength blue light keeps us active and alert. Both are important for our well-being. With this in mind, it is not just a matter of admitting sufficient light into the interior. The light should also cover the entire spectrum.

So the nature of the glass has implications for the quantity and quality of daylight entering the room?

Of course. Poor-quality triple glazing, for example, will entail a light loss of up to 30 percent. You run the risk of occupying a well-insulated, though insufficiently bright room. In this respect, however, there are now some good products on the market, e.g. triple glazing that can achieve the light transmittance values of double glazing. These serve to optimise insulation performance while minimising light loss.





Sunlight promotes a sense of well-being, though – depending on season and region – can also heat up interiors: hence the need to consider heat and glare protection from the very outset.

Sun/Heat → Solar protection

Darken, regulate solar gain, control glare and safeguard privacy.

Although windows admit light into spaces, this is not always desirable. The sun may sometimes be too bright, dazzle or heat up rooms. This can be efficiently prevented by means of good solar protection solutions. These also offer additional visual privacy, weather exclusion and burglary protection. During design, it is important to weigh up the benefits and drawbacks of the various options.

	Solar protection glass	Twin coupled sash with Venetian or pleated blind	Roller shutter
			
Glare and privacy protection	<input type="radio"/> always a clear view	<input checked="" type="radio"/>	<input checked="" type="radio"/>
Glare and privacy protection with views out	<input type="radio"/> always a clear view	<input checked="" type="radio"/> slats allow views through <input type="radio"/> pleated blind	<input type="radio"/> no views out when closed
Blackout	—	<input checked="" type="radio"/> slats do not black out completely <input checked="" type="radio"/> pleated blinds black out completely	<input checked="" type="radio"/> roller shutters black out completely
Thermal insulation: improved performance	—	<input checked="" type="radio"/> thanks to coupled sashes open and closed	<input checked="" type="radio"/> when closed
Less heating up from sunlight: reduced solar gain	<input checked="" type="radio"/> Mediterran, Sun-Control <input checked="" type="radio"/> Sun-Block	<input checked="" type="radio"/> when closed	<input checked="" type="radio"/> when closed
Sound insulation: improved noise control	—	<input checked="" type="radio"/> thanks to coupled sashes open and closed	<input checked="" type="radio"/> when closed
Security: improved burglary protection	—	—	<input checked="" type="radio"/> when closed
Weather action on windows: improved weather protection	—	—	<input checked="" type="radio"/> when closed
Operation	no operation required	chain, motor	belt, motor
Box above window	none	none	16 - 20 cm
Maintenance and care effort	no additional maintenance and care effort	hardly ever (due to protected location in gap between panes)	medium

External Venetian blinds

Fabric shade

Window shutter

**Internal solar protection
(Venetian blind, pleated blinds,
curtains)**



●	●	●	●
● slats allow views through	○ no views out when closed	⦿ depending on window shutter model	⦿ slats allow views through
⦿ slats do not black out completely	⦿ fabric does not black out completely	⦿ depending on model	⦿ depending on model
⦿ when closed	○ hardly any effect when closed	● when closed	⦿ depending on model
● when closed	● when closed	● when closed	⦿ depending on model
⦿ when closed	○	● when closed	○
⦿ when closed	○	● when closed	○
⦿ only when closed, in strong winds Venetian blind must be raised	● when closed	● when closed	—
motor	motor	manual	manual
20 - 30 cm	13 cm	none	none
high	medium	medium	low

— No additional impact

○ Low impact

⦿ Positive impact

● Very positive impact

Sun/Heat → Glass selection

As bright as day. Perfectly insulated. With solar protection to boot.

Window glass should deliver perfect insulation performance while protecting against excessive sunlight. At the same time, we want as much daylight as possible to enter the interior. Is that even possible? It is if you make sure you have high-quality glass. At Finstral, all insulating and solar protection glazing is manufactured in-house. For this, we use only the highest quality glass available on the market.

Plus-Valor

Without solar protection,
our standard for double glazing

Max-Valor

Without solar protection,
our standard for triple glazing

Double glazing

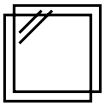

Triple glazing

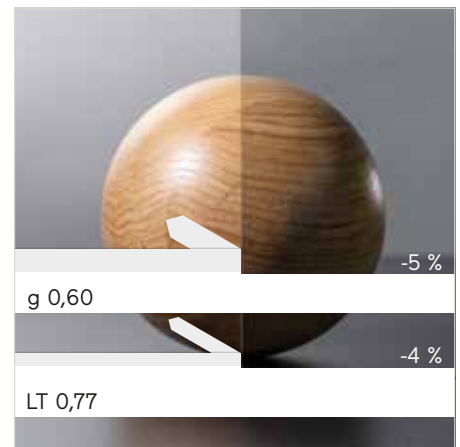
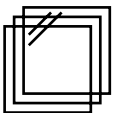

Mediterran

Low-level solar protection,
our standard for glass surfaces in subtropical
climate zones

Sun-Control

Medium solar protection,
our recommendation for large or sun-
exposed glass surfaces

Sun-Block

High-level solar protection, slightly reflective,
our recommendation for very large, sun-
exposed glass surfaces

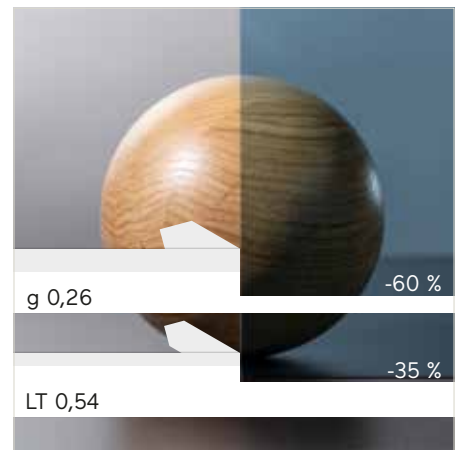
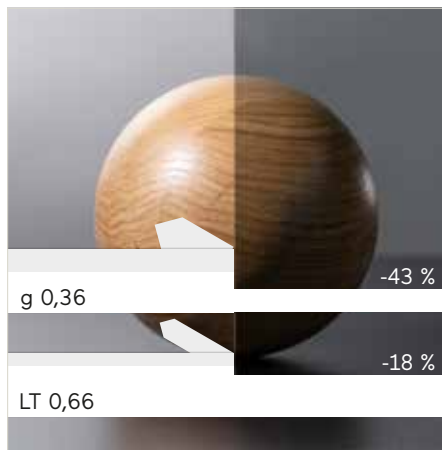
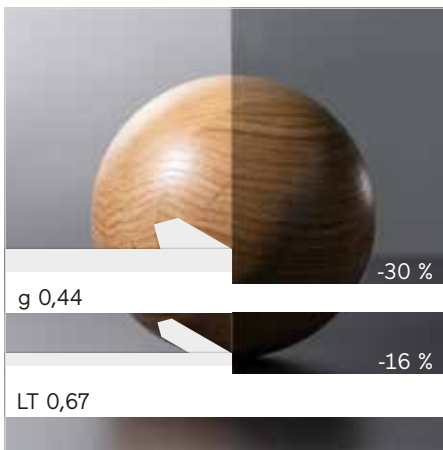
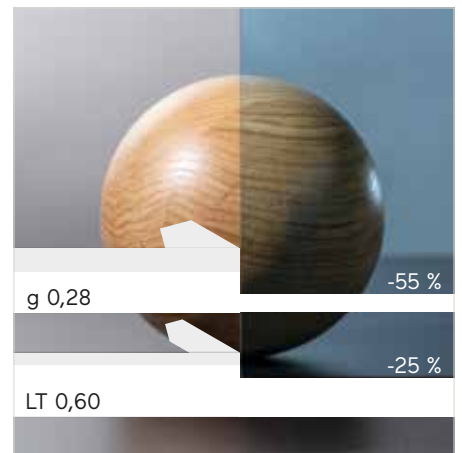
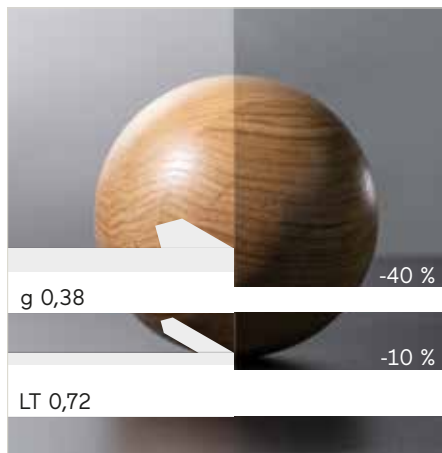
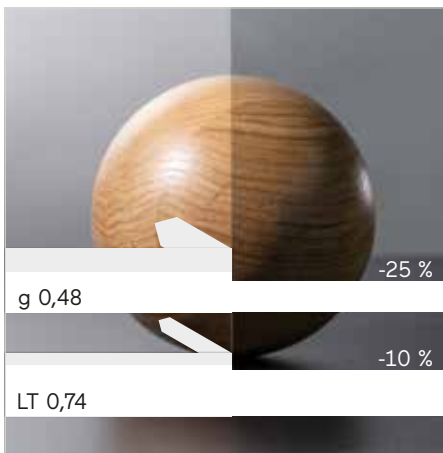

The percentages indicate the reduction in thermal energy transmittance (g) and light transmittance (LT) compared to our standard Plus-Valor 2 insulation glass.

Sun/Heat → Shading in sash

Solar and privacy protection in weather-protected gap between panes.

Having a flexible means of solar, light, privacy and glare protection is ideal at certain times of the day or in the warm, bright seasons. The Twin versions of Finstral windows and casement doors comprise two coupled window sashes. An aluminium Venetian blind or pleated fabric blind can be incorporated in the gap, where it can be readily operated by chain or motor and is always well protected against wind, rain and dirt.



Without box.

As the sunshading device is integrated in the window sash, it does not need its own housing above the window. This extra 10 to 20 cm wide glass surface at the top edge of the window admits disproportionately more light into the room than the remaining glass surface.



Just as narrow as sash without Venetian blind.

Despite the window's additional functions, the narrow frame elevations remain unchanged, even with the Twin coupled-sash model.



Easy-care and low-maintenance.

Dirt and bad weather pose no problems as the Venetian or pleated blind is located behind the outer pane. As a result, they stay clean and in proper working order for much longer. They can be readily cleaned and maintained from the interior.



Standard



Optional

Symmetric or asymmetric look.

With the Nova-line Twin sash model, the raised Venetian blind stack is hidden behind the top, black glass edge enamelling. Or you can opt for the version with symmetric enamelling where the blind stack remains visible.

FIN-Project Slim-line Twin aluminium-aluminium window and casement door, single-sash model, colour L56 similar to clear anodised special effect colour, with interstitial pleated blind (left) and interstitial Venetian blind (right).



Sun/Heat → Interstitial Venetian blind

Adjustable protection.

Venetian blinds are filigree and offer freely adjustable solar and privacy protection without any sense of confinement: when the blind is lowered, the view out can be regulated by adjusting the slat angle. The 25 mm wide slats are made from stable, lightweight aluminium.

Nine colours.

Available in nine colours, the slats can always be perfectly coordinated with the window frame and sash design.

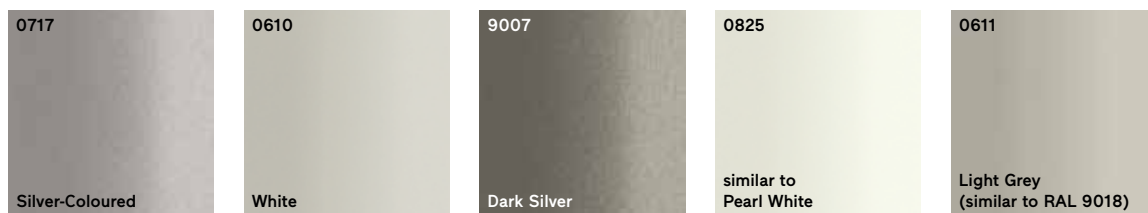

Light control through slat effect.

Depending on the slat angle, you can darken the room to varying degrees – though without completely blacking it out.

→ Interstitial pleated blind

Completely light-proof.

Certain rooms, e.g. bedrooms, should have provision for being completely blacked out. Here we recommend our coupled sash with interstitial, light-proof honeycomb pleated blind.

Four colours.

The light-proof honeycomb pleated blind is available in four colours on the interior face. To ensure good energy reflection, its exterior face is always in Light Grey.



Exterior



Interior



Completely light-proof.

The lateral C-rail ensures that the room is completely blacked out.



Guide rail black on inside.

To prevent any lateral light reflection, the inside of the guide rail is coated black.

Sun/Heat → Roller shutter

Light-proof solar protection with additional thermal insulation.

Roller blinds are all-rounders: lowering them not only blacks out rooms, but also consistently keeps out heat. Moreover, lowered roller shutters improve thermal insulation by 10-20 % while significantly increasing sound insulation and weather protection. They also pose an additional obstruction for burglars. Roller shutters are combinable with an insect screen roller blind and motorised ventilator on request. They can always be conveniently operated by belt or motor drive (Smart Home compatible).

Aluminium roller shutter curtain in 28 colours.

uPVC slats may become warped when exposed to heat, thereby impairing performance. That is why Finstral always manufactures its roller shutter curtains from aluminium – a durable, heat-resistant material that retains its shape.



Exposed or concealed guide rails.

The roller shutter guide rails can be surface-mounted, in the same colour as the frame, or flush-mounted and concealed by the render.

With or without light and ventilation slits.

The roller shutter slats can be designed with light and ventilation slits or – for complete blackout – without light slits.

Always the right type of installation.

We offer three variants for mounting our roller shutters, with exposed or concealed installation. Existing roller shutter boxes are insulated during refurbishment.

More information can be found under: [Centre → Building connection → Mounting method → Shading device boxes](#)

FIN-Project Slim-line aluminium-aluminium window and casement door, double-sash model, colour M812 Red Brown matt full-strength, roller shutter with aluminium slats colour G32 Oxide Red, with vertical insect screen roller blind (left), fixed to mounting frame.



Sun/Heat → External Venetian blind

Effective solar protection. Though still with visual links.

While being particularly elegant in appearance, external Venetian blinds offer a combination of flexible solar protection and views out. When raised, they disappear into a compact box behind a facing or render finish. When lowered externally in front of the window, they protect against light, heat and prying eyes. When tilted, the visual links with the outside are retained while daylight is reflected onto the ceiling. An insect screen or motorised ventilator may be optionally integrated.

Aluminium in a host of colours.

As the slats of our external Venetian blinds are always made of aluminium, they offer reliable stability, durability and heat resistance. You have a choice of five colours. A further 12 special colours are available on request.

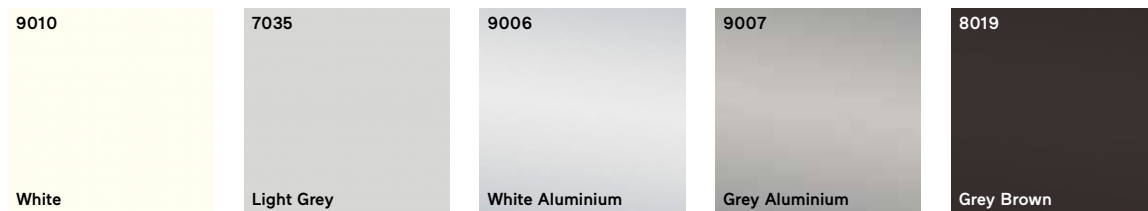

Guide rails.

The slats run along surface-mounted or concealed guide rails which prevent the blind from rattling in windy conditions. The visible parts of the boxes and guide rails are always colour-matched with the window frame.



Two slat widths.

We offer two different widths: 80 mm (C shape) and 92 mm (Z shape). The 92 mm wide slats are more stable and provide better darkening.

Suitable installation.

We always install our external Venetian blinds with a thermally insulated mounting frame and with the box concealed on the interior.

More information can be found under [Centre → Building connection → Mounting method → Shading device boxes](#)

FIN-Project Slim-line aluminium-aluminium window and casement door, single-sash model, colour M505 Signal Blue matt full-strength, external Venetian blind with 92 mm Z-slats, colour 9007 Grey Aluminium, with vertical insect screen roller blind (left), fixed to mounting frame. Our external Venetian blinds can always be conveniently operated by motor drive, with Smart Home compatibility as an added option.



Sun/Heat → Fabric shade

Modern solar and privacy protection – made from fabric.

Would you like an aesthetic eye-catcher for your façade that simultaneously protects against sun, heat and prying eyes, though without completely blacking out the room? Then our exterior, semi-transparent fabric shades offer the ideal solution. Our fabric shades can always be conveniently operated by motor drive, with Smart Home compatibility as an added option.

uPVC-coated polyester fabric.

The polyester fabric is particularly weather-resistant and reliably protects against UV rays. It is available in seven light-fast colours. To prevent the shade from flapping in the wind, it is guided along rails at the side. Other fabrics and colours are also available on request.

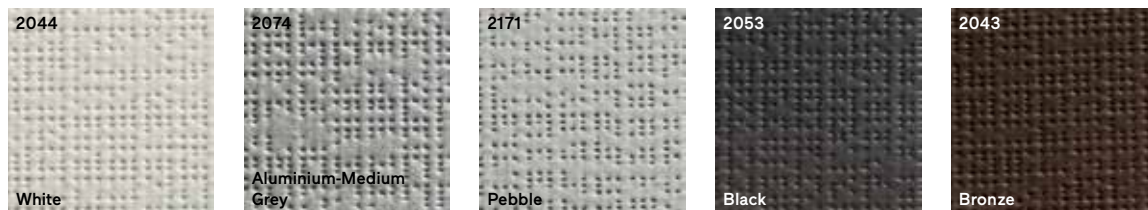

Glass-fibre fabric.

The glass-fibre fabric is air-permeable and see-through to offer good views out. You have a choice of three light-fast colours. The glass-fibre shade is likewise fitted in a guide rail to prevent it from flapping in the wind. Other fabrics and colours are also available on request.



Suitable installation.

We always install our fabric shades with a thermally insulated mounting frame and with the box concealed on the interior. More information can be found under: [Centre → Building connection → Mounting method → Shading device boxes](#)

FIN-Window Slim-line uPVC-uPVC window and casement door, double-sash model, colour 45 White satin finish, glass-fibre fabric shade, colour 001010 Grey-Charcoal, fixed to mounting frame.



Sun/Heat → Hinged shutters

The traditional solution for solar and privacy protection.

Hinged shutters are much more than a distinctive design feature of building façades. How much light and heat do you want to admit into your interior? How much visual privacy do you need? The fixed or movable slats and push-out flaps of hinged shutters allow optimum control of daylighting, shading and views into the building. As hinged shutters are highly stable and can be locked from the inside, they also offer enhanced burglary protection.

In-house-produced uPVC.

Unlike aluminium, uPVC is not thermally conductive and does not transfer outdoor temperature conditions to the window. The material offers the same insulating performance as wood while being more weather-resistant, practically maintenance-free and extremely durable. Our hinged shutters are available in 10 uPVC colours and 34 coated versions as well as in other RAL colours on request.



Infill panels.

Standard hinged shutters are available with four infill panel designs: flattened, milled, horizontally boarded and vertically boarded.



Shapes.

You can choose between angled shapes and round, segmental or pointed arches. All are available as single- or double-leaf models. Angled shapes and rectangular leaves are available as folding elements.

Opening action.

Hinged shutters can be made with one to four leaves, with a maximum of two leaves joined together to form a folding element. These folding leaves allow the shutter to open to one side, thus creating a large window opening.

Also available with push-out flap.

The push-out flap vouches for full solar protection while also allowing for close control of light incidence and air supply.

Always the right type of installation.

We offer four different mounting variants to cater for the project-specific circumstances.

More information can be found under [Centre → Building connection → Mounting method → Hinged shutters](#)

FIN-Window Slim-line uPVC-uPVC window and casement door, double-sash model, colour 42 White embossed, hinged shutter with flattened infill panel and push-out flap, fixed to facing frame (left), hinged shutter with fixed, closed slats and movable slats, with leaf transom, fixed to frame (right), both in colour 15 Green embossed. Movable slats allow optimum control of light incidence, air supply and views into the building. Hinged shutter hardware is always in black.



Sun/Heat → Board shutters

Efficient solar protection for traditional architecture.

As a mark of respect for vernacular building traditions and to cater for a more rustic architectural style, Finstral offers its distinctive boarded shutters in three models. Whether in embossed or satin-finish uPVC, all board shutters are manufactured in-house.

Colours and finishes.

Finstral board shutters are available in 11 uPVC colours and some 30 coated versions.

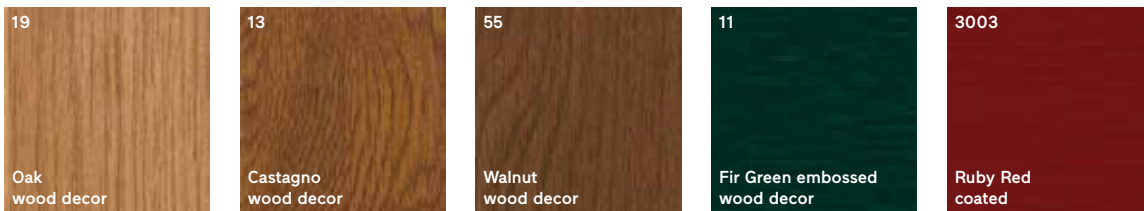

Padovana and Vicentina.

In addition to the standard version (1), we also offer a Padovana-style board shutter, which folds open around the masonry reveal (2), and as a Vicentina-style model, which opens inwardly into the reveal (3).

→ Interior shutter

The Mediterranean minimalist.

Typical of southern Italy, these window shutters offer solar and privacy protection that is easy to operate from the inside. Our interior shutters are always made of wood fibreboard faced with a just under 1 mm thick plastics film. In case of strong sunshine, we recommend that you combine the interior shutter with an exterior sunshading device.

Colours and finishes.

Our interior shutters are available in the standard uPVC colour range.



Infill panels and shapes.

You can model your interior shutters with various infill panels as pictured here, e.g. with a boarded (4) or milled (5) design. They are, of course, also available as angled elements or round arches.

Sun/Heat → Sliding/folding shutters

Solar and privacy protection with a modern touch.

Finstral's sliding and folding shutters offer outstanding protection against the sun and heat while safeguarding visual privacy. And they can also be used to near-completely black out the interior. Moreover, they provide additional insulation against noise, heat and cold. The slats are made of weather-resistant aluminium.

Colours and finishes.

Sliding aluminium shutters are available in around 250 colours.

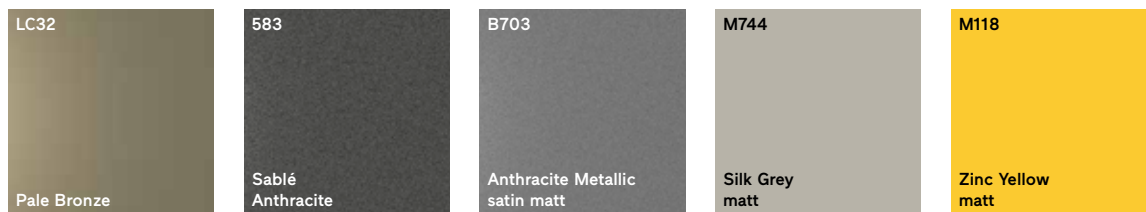

For sliding, folding or as fixed unit.

Sliding and folding shutters are suitable shading devices for windows, casement doors and sliding doors. They also serve as windbreaks or privacy screens for patios and canopied areas. Fixed units are used as balcony partitions or permanent privacy screens.



Sliding element design.

Sliding elements are available as single- or double-leaf models, with manual or motorised operation.

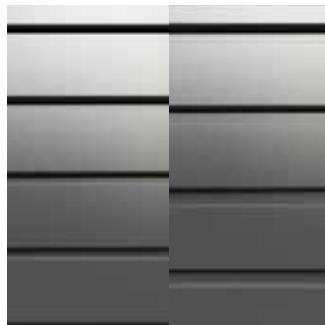

Too much or not enough light and air?

Depending on your personal wishes or the need for light and air, the slat profiles can be fitted in the aluminium frame without a gap (0 mm) or with a gap of 10 mm or 16 mm.



Also available with glass infill panel.

Combinations of panels with slats and glass lights or fully glazed panels are also possible. As glazing options, we offer both transparent and translucent safety glass.

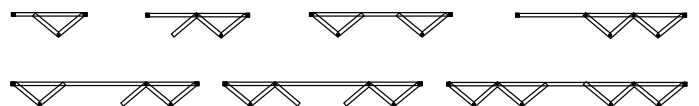

Sliding/folding element design.

Folding elements are available in a variety of designs, from a two-part folding shutter to an eight-part folding shutter with flying mullion.

FIN-Project Slim-line aluminium-aluminium window and casement door, single-sash model, colour M511 Steel Blue matt full-strength, with aluminium sliding shutters and facings in frame colour.



Privacy → Patterned glass

Aesthetic and translucent.

Privacy protection with low light loss? Our patterned glass, with its varying levels of transparency, can offer both. With a dozen or so design options, Finstral can supply a wide range of stylish glass finishes – including fracture-resistant versions made of safety glass. Or you can order glass bearing your own customised, sandblasted or enamel-printed motif to match your ideas or designs.

Greater burglary protection, lower risk of injury



Three versions of our patterned glass (48, 86, 88) can be fitted with Multi-protect safety glass, whose highly tear-resistant film prevents the glass pane from shattering in the event of breakage.



Three versions (19, 31, 48) as well as sandblasted or printed patterned glass are available with Bodysafe safety glass, which ensures maximum impact resistance and minimum risk of injury.



18 Cathedral White

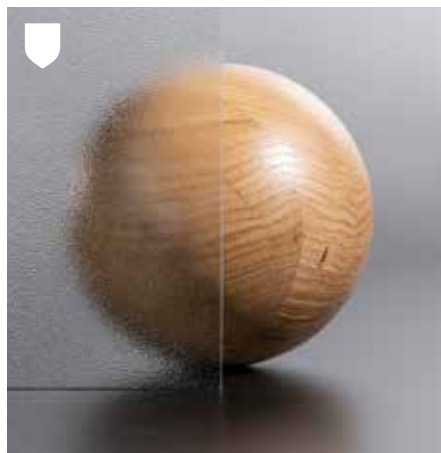

19 Orn. C – Orn. 504

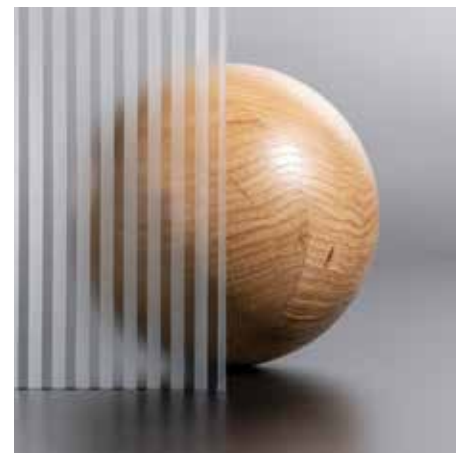

27 Basic White



28 Pavé White



31 Chinchilla White



33 Baroque White

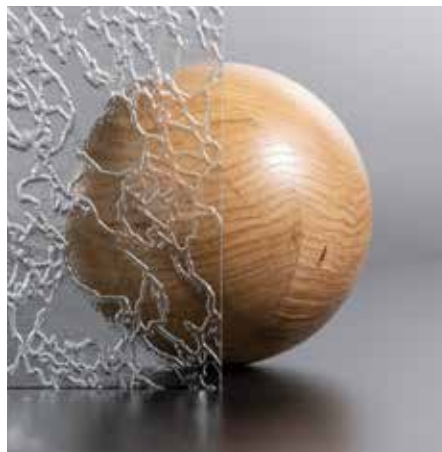

35 Delta White



48 Matt glass White



86 Kyoto



88 Miami



415 Parsol Grey



S01 Custom-sandblasted



Custom-printed, e.g. pattern



Custom-printed, e.g. characters

Insects

→ Insect protection

Aesthetic protection against uninvited guests.

Light on, window open. And there they are, those unwelcome guests. Finstral's perfectly fitting insect screens offer a well-functioning, yet visually discreet remedy. They enable you to keep your living spaces insect-free even when windows and casement doors are open. Our insect screens, like other products, are manufactured in-house. Which means they always match the window frame in shape and colour while also being combinable with roller shutters and external Venetian blinds.

Insect screen for windows.

Fixed screen frame

The fixed insect screen frame – also available in angled shapes – can be inserted into and removed from the window.



Vertical insect screen roller blind

The vertical insect screen roller blind is equipped with a convenient locking mechanism and a recoil mechanism.



Insect screens for casement and sliding doors.

Screen frame as side-hung door

For balcony and patio doors, the fixed insect screen is available as a side-hung door.



Pleated blind screen, horizontal

The lower-cost, horizontally running pleated blind is collapsible and – unlike a roller blind – needs no box.



Roller blind screen, horizontal

The horizontally sliding insect screen roller blind is installed with a box and without a threshold. The net is freely positionable.



Centre → Insulation
State-of-the-art core
that insulates perfectly.



Heat/Cold
Noise
Tightness



Heat/Cold

Always a pleasant indoor climate.

Windows separate the inside from the outside and play a crucial role in regulating the indoor temperature. Their insulation performance determines whether a space cools down or heats up. That is why it is so important to make provision for good insulation as early as the design stage.

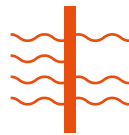

g-value: solar gain.

The g-value indicates how much solar energy passes through the glass. The lower the g-value, the lower the energy transmittance.

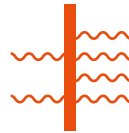

U-value: thermal transmittance.

The U-value indicates how much energy is kept out by the glass and frame. The lower the U-value, the better the insulation performance.

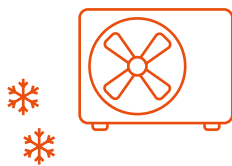

Cooling is more expensive than heating.

Cooling a room by one degree consumes roughly three times more energy than heating it up by one degree. Good insulation is thus particularly advisable in Mediterranean regions, where air-conditioning tends to be needed for longer periods of the year than heating.



Insulation in cold weather.
Windows keep rooms warm when it is cold outside.



Insulation in hot weather.
Windows keep rooms cool when it is hot outside.

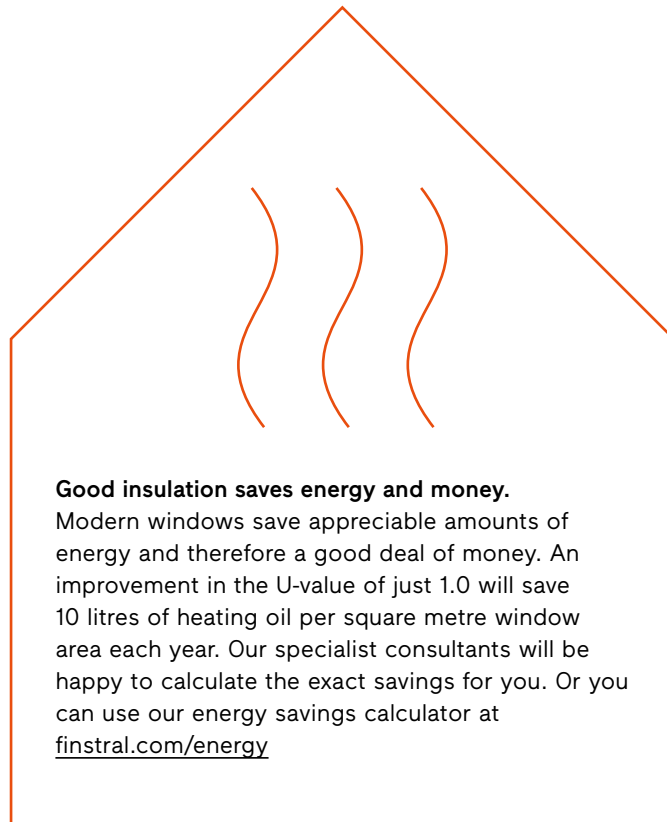

The basics of perfectly insulating windows: frame, glass and installation.



Good frame.

The optimum material for perfectly insulating frames is uPVC.

Why? Because, unlike aluminium, it is non-conductive. Because, unlike wood, it does not weather. And because it is the only material that allows proper welding and sealing at corners, and is therefore absolutely weathertight.



Good glass.

High-quality ingredients are essential for perfectly insulating glass. Flat glass with state-of-the-art coatings in double- or triple-glazed assemblies with corner-welded, thermally insulated spacers and filled with argon gas delivers the best insulation performance.



Good installation.

Good-practice installation accounts for up to one-third of a window's insulation performance. What this requires: a detailed and technically correct design of the building connection for each window plus installers who undergo regular training.

Heat/Cold → Frame

uPVC is the best insulator.

Finstral always opts for uPVC for its frames as this delivers the best insulation performance of all common frame materials. We develop and manufacture the thermally insulating frame profiles in-house – using pure, unmixed, high-quality uPVC with generous profile wall thicknesses. This makes them durable, colour-fast and 100% recyclable. Moreover, for maximum insulation, our profiles are always corner-welded and the gaskets firmly co-extruded onto the profile.

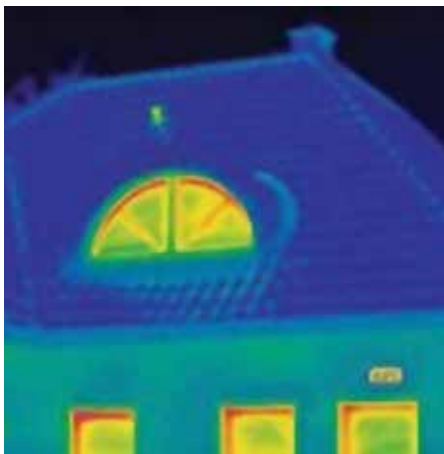

Well-insulating frames are important.

Thermal imaging cameras show a clear picture: old or poorly insulated windows lose heat not only through the glass surface, but above all via the frame.

Our guiding principle: the highest standard.

Finstral windows set the market benchmark. Even our standard versions with a construction depth of 77 mm achieve top insulation values:

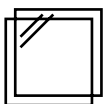

with double glazing
 U_w 1.0-1.2 W/m²K

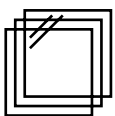

with triple glazing
 U_w 0.73-1.1 W/m²K

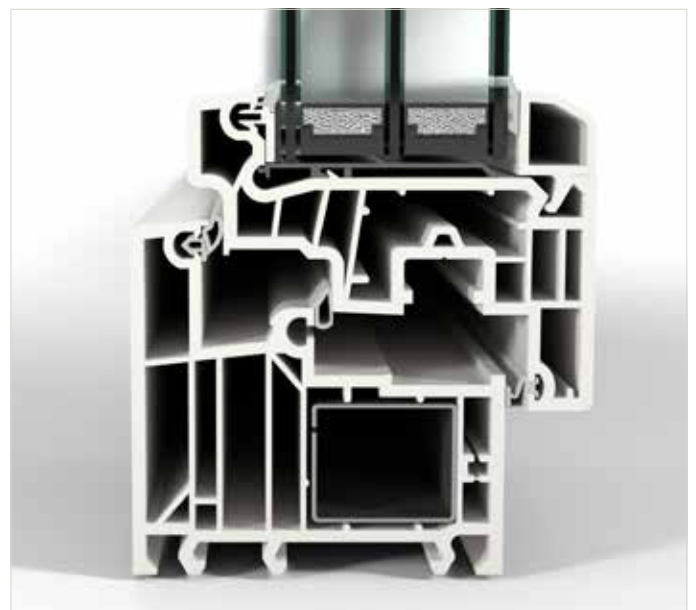

Section through a Finstral uPVC frame:
FIN-Window Slim-line 77 uPVC-uPVC

Top value U_w 0.71 W/m²K

With the FIN-Window Nova-line Plus 90 model, Finstral windows achieve top insulation values of up to U_w 0.71 W/m²K. This is due to the use of a profile with an increased construction depth of 90 mm and – to improve separability – with only inserted insulating strips and frameless sash designs.

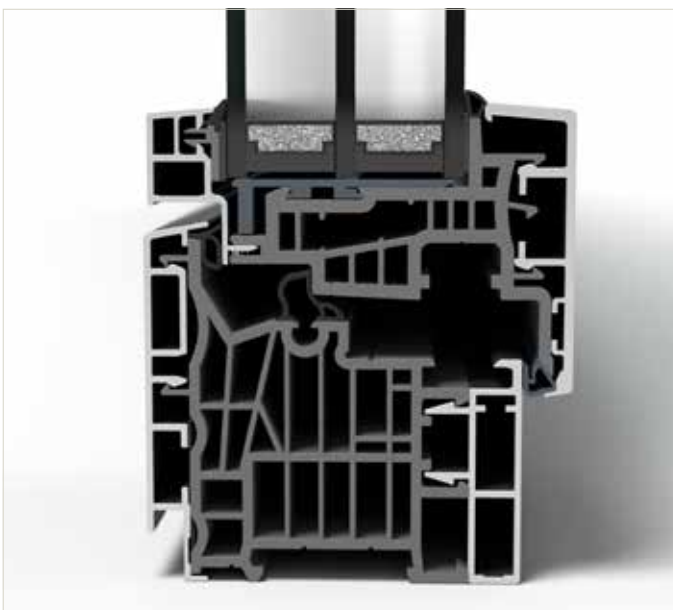
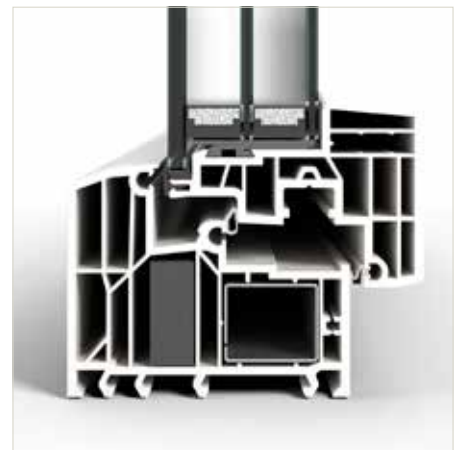

(Wood-)aluminium windows: reinvented.

Even Finstral's aluminium or wood-aluminium windows are always fitted with a uPVC core, despite this not being visible when the window is closed. This allows us to combine the modern look of aluminium with the outstanding insulating properties of uPVC – while optimising the separation of materials into pure, unmixed components for recycling:

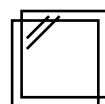

with double glazing

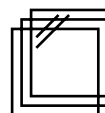

U_w 1.1-1.3 W/m²K
with triple glazing
 U_w 0.77-1.1 W/m²K

Section through a Finstral aluminium frame:
FIN-Project Slim-line 78 aluminium-aluminium

All insulation values are presented at the back of the catalogue and at finstral.com/range

Heat/Cold → Insulation glass

Insulation glass meeting the highest standards – produced in-house.

Finstral manufactures insulating glass units in its own state-of-the-art factories to cover its demand. First, the gigantic standard glass panes are cut to the required sizes in a digitally optimised operation that minimises offcut and waste of the valuable material. Any residue is collected and remelted by the glass manufacturer. The panes are then seamed and, if required, printed or toughened in our own tempering kiln prior to their assembly with high-grade, corner-welded spacers into double- or triple-glazed insulating glass units. Finally, we use laser scanners to verify that every finished insulating glass unit is in flawless condition.



Always quality-controlled.

What makes glass valuable is the high amount of energy needed for its production. Sustainability considerations alone thus demand its careful treatment. To achieve high quality and avert customer complaints, our laser scanners check the insulation glass units for air bubbles, inclusions, scratches and impurities more rigorously than required under the relevant European standard (EN 1279-1:2018 “Glass in building”).

More information on this subject can be found in our window operating instructions at [finstral.com/manuals](https://www.finstral.com/manuals)



Always seamed edges.

Glass edges always undergo a special treatment at Finstral in which they are seamed using a diamond grinder. This additional step reduces the risk of glass breakage during the window's long service life.



Always high-quality spacers.

Thermally insulated spacers can save around 8% of a building's heating energy demand each year.* Finstral uses only premium-grade uPVC spacers which are not bent at the corners, but mitre-cut and perfectly welded together.

* according to a study by the Passive House Institute in Darmstadt, June 2017

→ Double/triple glazing

Always warm when it's cold outside.

Light comes in, cold stays out. That is the purpose of insulation glazing – and Finstral's insulating glass units always do a perfect job. Our Plus-Valor 2 double-glazed and Max-Valor 3 triple-glazed insulating glass units achieve the top values for insulation, energy and light transmittance in their respective categories. Finstral always offers you the best insulation glass on the market.



The best is our standard:

Plus-Valor 2 double insulation glazing

- standard for Finstral: premium-quality components, state-of-the-art processing and excellent thermal insulation values
- best achievable values for thermal insulation U_g 1.1 W/m²K, total energy transmittance g 0.63 and light transmittance LT 0.80
- gap between panes always filled with thermally insulating argon gas
- always high-quality, thermally insulated and corner-welded glass spacers
- spacers available in White or Light Brown instead of Black on request



Just as much light as a double-glazed unit:

Max-Valor 3 triple insulation glazing

- our best insulation glass: thermal insulation performance almost twice that of Plus-Valor, though with remarkably low loss of brightness compared to double insulation glazing
- best achievable values for thermal insulation U_g 0.6 W/m²K, total energy transmittance g 0.60 and light transmittance LT 0.77
- gap between panes always filled with thermally insulating argon gas
- almost as colour-neutral as white glass
- always high-quality, thermally insulated and corner-welded glass spacers in elegant Black
- reflectance of only 15%, making it bird-friendlier

Windows provide light and fresh air. They keep out heat and cold while creating a barrier against the wind, rain and noise. All this is purely mechanical and practically maintenance-free for decades. Windows may not look like highly complex building elements, but they are. As Head of Systems Engineering, Franz Gufler knows why Finstral windows rank among the best, also in terms of insulation.

“uPVC is the ideal material for windows.”

How does a window have to be designed to achieve optimum insulation performance?

Three factors determine the insulation value of a window – frame, glass and installation. At Finstral, we always use uPVC for the frame as a matter of principle. Unlike aluminium, for example, it is non-conductive, nor does it weather. And, because the frame corners can be welded, it ensures that windows are absolutely weathertight. uPVC is simply the ideal material for windows.

And what role does the glass play?

Insulation glass usually consists of two or three panes, a spacer and a filling of argon gas in the gap between the panes. Here, differences in quality are determined by the quality of the ingredients: truly modern glass coatings not only insulate, they also admit far more daylight into the interior. And really good spacers must be thermally insulating and corner-welded. At Finstral, all insulating glass units are manufactured in-house and, as a fundamental principle, using only the best materials and components on the market.



Franz Gufler has been developing Finstral window systems for 15 years – for nearly two years as Head of the Systems Engineering department.



15 to 25 percent of heating energy can be lost due to poorly insulated windows: well-insulated buildings will significantly cut heating costs.

Which leaves the subject of installation ...

Which is crucial. Around one-third of a window's insulation performance depends on its proper installation. That is why we attach such a high priority to having trained installers. Working in tandem with the Institut für Fenstertechnik (ift) Rosenheim, we have launched the most rigorous qualification programme in Europe.

How do Finstral windows achieve such good insulation values?

The fact that we do everything ourselves – from development to production and assembly – enables us to offer a higher quality standard. What makes our windows special, then, is the triply unique quality of frame, glass and installation.

How can you increase thermal insulation performance?

Thermal insulation can be improved by thicker frame profiles and triple glazing. This is always recommended in case of big differences between indoor and outdoor temperatures. In cold regions, where it needs to be warm indoors, or in very hot areas with air-conditioned interiors. Cooling a room by one degree consumes roughly three times as much energy as heating it up by one degree. And this energy should not be allowed to escape through the window.

When are special thermal insulating glass units useful?

The need for double or triple glazing depends on what climate zone you inhabit and whether the interior is air-conditioned. With air-conditioning, I always recommend maximum insulation by means of triple glazing. Moreover, in Mediterranean regions, air-conditioning is needed for longer periods of the year than heating. Another important factor in this connection is that our triple insulation glazing is just as translucent as double glazing.

How can I calculate if and when my new windows will pay off?

New windows always pay off. They are the easiest element in a building to replace and bring along a whole host of advantages. Let's start with insulation: this is measured in terms of thermal transmittance, i.e. the U-value. Here, an improvement of 1.0 will save some 100 kWh of heating (equivalent to approx. 10 m³ of natural gas) per square metre window area each year. This is a rough guide value – our specialist consultants will be happy to calculate the exact savings for you. And they can also demonstrate how new windows improve burglary protection and admit more light into the building while being easy to clean and practically maintenance-free. And reducing noise. The first thing our customers notice after a window replacement is that it is quieter.

What are the key requirements for sound insulation?

Given that constant noise makes us ill, the importance of sound insulation should not be underestimated. From a technical point of view, two factors are crucial: on the one hand, all joints must be absolutely soundproof. Finstral products perform particularly well here because our gaskets are co-extruded onto the frame profiles for lasting dimensional stability. Because we bond the glass to the frame rather than just using glazing blocks. And because the numerous locking points between sash and frame vouch for a high contact pressure. Apart from that, an asymmetric design and wide gaps also serve to reduce noise levels. If all that is factored into the assembly of a Finstral window, a sound reduction of up to 47 dB is achievable.

Noise

Soundproof and quiet.

The ear is the most sensitive human sensory organ – and is permanently active. Even when we sleep, it registers and evaluates every sound. Our body can become accustomed to many things, but not to noise. That is why even Finstral's standard windows are designed to fit tightly and are always expertly installed to achieve an optimum sound insulation level of 32 to 36 dB. And what if the noise disturbance is particularly high? That is why our range includes special noise protection glazing.



Can noise be measured?

As noise is a subjective sensation, it cannot be measured. However, the sound pressure level, expressed in decibels (dB), can be exactly determined. A change of 10 dB roughly corresponds to a doubling or halving of the sound intensity. The sound pressure level provides an indication of how loud or quiet a sound, tone or noise actually is.

Noise perception

10 dB slight rustling of leaves
30 dB quiet bedroom at night

Sleep and recuperation impaired by constant exposure



40 dB quiet conversation
50 dB dishwasher

Stress threshold



60 dB loud conversation

Increased cardiovascular risk under constant exposure



80 dB loud road noise

90 dB car horns, truck noise

100 dB motorcycle, disco noise, Oktoberfest tent

110 dB express train nearby, concrete breaker

120 dB Siren at distance of 10 m

Pain threshold



130 dB Jet plane nearby

Noise makes you ill.

As numerous studies have shown, noise is a stress factor for the body. Even low noise levels from 25 dB upwards can lead to sleep or concentration disorders. Permanent exposure to over 65 dB during the day and over 55 dB at night will increase our risk of developing high blood pressure and, as a result, cardiovascular illnesses.



Our perception of sound.

Whether we like a sound or experience it as a disturbance also depends on its nature. While we associate a waterfall in an idyllic mountain setting with relaxation, a busy motorway with the same sound pressure level verifiably causes stress.





20 %

of the EU population is, according to the European Environment Agency (EEA), permanently exposed to sound pressure levels that are harmful to health. The main source of noise pollution is road traffic, followed by rail and air traffic, and industry.

**30 dB**

is the threshold recommended by the World Health Organization (WHO) for a restful night's sleep. An upper threshold of 40 dB applies as the guide value for daytime comfort in living spaces.

Achievable noise protection.

Road noise in function of traffic density	Recommended sound insulation class under VDI* Guideline 2719	Noise protection by windows
 Residential street (10-50 vehicles/h) → approx. 55-64 dB	I 25–29 dB	Old windows with double glazing: Sound reduction of -25 dB
	II 30–34 dB	Finstral windows with double insulation glazing: Minimum sound reduction of -32 dB
 Residential street (50-200 vehicles/h) → approx. 65-69 dB	III 35–39 dB	Finstral windows with double insulation glazing: Sound reduction of -38 dB
 Main road (1,000-3,000 vehicles/h) → approx. 70-79 dB	IV 40–44 dB	Finstral windows with double insulation glazing comprising Multiprotect (laminated safety glass) or as Twin coupled sash: Maximum sound reduction of -46 dB
	V 45–49 dB	
 Main road (3,000-5,000 vehicles/h) → approx. 80 dB	VI > 50 dB	Finstral double window: Maximum sound reduction of -59 dB

* Association of German Engineers

Noise → Sound insulation

Close the windows for peace and quiet!

That's how we would like it to be. And that's why even Finstral's standard windows are extremely well soundproofed. The better the frame fits, the better the insulation performance – that's why we always bond frame and glass instead of using the otherwise standard glazing blocks. We also ensure that the gaskets are firmly connected to the profile and position the locking points with minimum spacings. And, in particularly demanding cases, we offer special noise protection glazing that insulates up to twice as well against sound.

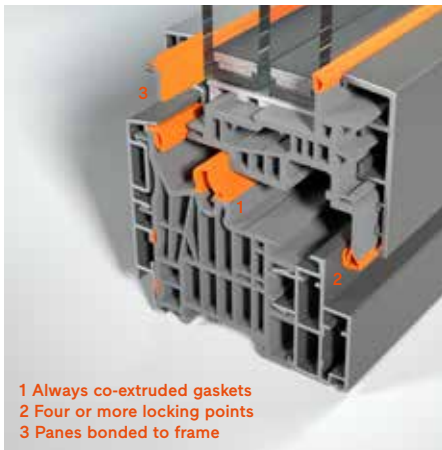

- 1 Always co-extruded gaskets
- 2 Four or more locking points
- 3 Panes bonded to frame

Always with soundproof design.

The particularly tight-fitting construction of our windows is the ideal precondition for optimising noise protection: co-extruded instead of fitted gaskets; four or more locking points, and insulation glass that is always bonded to the frame instead of just being fixed with glazing blocks.

Quieter as standard: with asymmetric glass thicknesses.

Asymmetrically designed insulating glass units break up the sound. This is achieved by using inner and outer panes of different thicknesses. Wide gaps between the panes and triple glazing further improve noise insulation – making sound insulation values of 32 to 38 dB achievable.



Section through window with double insulation glazing, design 4v-18-6F

**The whisper-quiet top value:
with two times noise protection glass.**

For a peaceful night's sleep near even the loudest of roads, we recommend the use of Multiprotect laminated safety glass for both the inner and outer panes. This makes sound insulation values of up to 47 dB achievable. Double windows offer even better sound insulation: see next page.

Section through window with triple insulation glazing, designed with Multiprotect laminated safety glass on inside and outside, design 44.2Sm-13-4F-13-66.2Sm

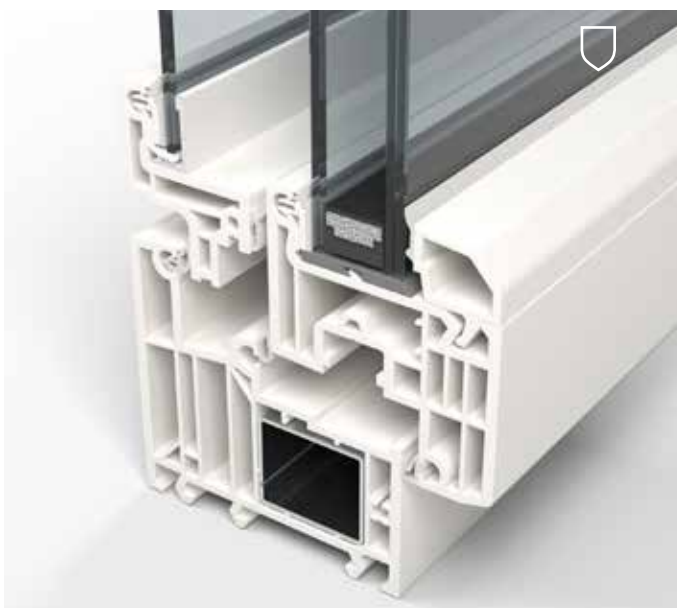

**Even quieter if required:
with noise protection glass and coupled sash.**

A significant improvement in sound insulation is achievable with our noise-insulating Multiprotect laminated safety glass. The film bonded between the panes offers additional burglary and UV protection. Models incorporating the Twin coupled sash likewise provide for greater sound reduction thanks to the wide gap between the panes. With these options, sound insulation values of 38 to 47 dB are achievable.

All sound insulation values are presented at the back of the catalogue and at [finstral.com/range](https://www.finstral.com/range)

Section through coupled-sash window with three panes, inner pane with Multiprotect laminated safety glass, design 33.1v-20-4T/6F0

Noise → Double window

Two sashes insulate better than one.

All Finstral windows offer outstanding insulating properties. Yet sometimes – e.g. where the noise levels are especially high – the particular situation poses an unusual challenge. In such cases, the barrier effect of our insulating products can be significantly improved still further through the use of two superimposed windows, both opening inwards. Finstral's solution offers a functionally and aesthetically up-to-the-minute interpretation of the time-honoured double window principle.



One mounting frame, two windows.

The principle behind the Finstral double window is the same as the one we know from older buildings: exterior window, intermediate space, interior window. For this, we have developed a brand-new “double version” of our innovative FIN-Fix mounting frame, which is incorporated in the masonry during the new-build or refurbishment works. Not only does it guarantee a perfect connection to the structural fabric, it also serves as a modular interface, offering full freedom of choice as regards the specific composition of the two windows.

Four times quieter than quiet.

Even a single Finstral window protects against noise levels of up to 32 dB – and, with sound insulation glazing, up to 47 dB. This suffices in most cases. Yet, it may well be worth installing our double windows if there is an airport or motorway junction nearby. With these, even higher sound insulation values of up to 59 dB are achievable.

Doubly insulating.

Our double windows also deliver top thermal insulation values of up to U_w 0.65 when fitted with two times double glazing. This is double the value of standard double glazing and a full 30 % higher than with our triple glazing.

Unlimited design freedom.

Virtually the full range of functional and aesthetic options is available for both elements of the Finstral double window. All frame shapes plus all aluminium and uPVC finishes are available for both the exterior and interior windows. The interior windows can be supplied in any of the real wood or inlay designs and with all opening and operating options. The full range of shading, insect screen and windowsill solutions can also be fitted.

FIN-Project aluminium-aluminium double window, in the form of a double-sash casement door and double-sash window, Slim-line Twin exterior sash, Nova-line interior sash, colour F716 Anthracite Grey fine texture full-strength, with Venetian blind, colour 0717 Silver-Coloured, handle series 11 coated in frame colour.



Too much noise can make you ill. Complete silence triggers a feeling of discomfort. The optimum level for a living environment lies somewhere in between. That windows are important for noise protection is obvious. Yet, high-quality soundproofing glass alone is not always enough. Engineer Ruben Erlacher on finding the best combination of glass, frame and installation detailing.



As a soundproofing expert, Ruben Erlacher from architecture and engineering firm Erlacher in South Tyrol knows what construction clients should look for when choosing windows.

“The window plays a key role in sound insulation.”

As a soundproofing expert, do you aim to minimise the amount of noise entering the interior?

Yes, in principle. After all, sound control, i.e. the acoustic quality of a building, is one of the key criteria in housebuilding or refurbishment. At the same time, excessive insulation of the façade against outdoor noise may be counterproductive because the quieter the room, the more you notice low-level noise sources. We need a certain form of acoustic link to the outside world, but it should lie below the standard values.

Because too much noise can make you ill ...

Exactly. A persistent level of noise, for example, can cause high blood pressure. Above all in cities, we are exposed to round-the-clock noise. This makes our need for peace and

quiet all the greater. We need to unwind within our own four walls. That is why sound insulation between apartments and between indoors and outdoors is so important.

Isn't the perception of noise primarily subjective?

You could even say: the worst noise is the one that you don't want to hear. Whatever that might be: a mosquito at night or traffic on the main road. And precisely the fact that noise perception is so subjective makes it important to have sound measured by experts. This allows an objective evaluation of the acoustic disturbance. Is the noise below the permitted level or above it?

What types of sound are there?

The two most important types are airborne sound and

structure-borne sound. Airborne sound is noise transmitted through the air, such as music or street noise. Structure-borne sound is transmitted via the parts of a building. One example is impact sound, e.g. footsteps on the floor of the above apartment or the sound of furniture being moved. Another type of structure-borne sound is the noise made by mechanical building installations, e.g. toilets flushing, garage doors, roller blinds, air-conditioners or heating systems.

How does airborne sound enter the interior?

Noise can penetrate wherever there are weak spots. These are usually windows, which are complex building elements with numerous functions, often ageing and not airtight as a result. Window areas are also increasing in size. Although this is basically a good development, as more light is admitted into the interior, it also makes sound insulation all the more vital. The window is quite clearly the most important component of the façade – also in terms of sound insulation.

As construction client, what should I look for when selecting my windows so as to make my home as quiet as possible?

A window's quality depends on finding the best combination of glass, frame and installation detailing. Most people only look at the sound insulation offered by the glass, which is a fatal mistake because the frame design and the way

the window is installed also have a major impact on sound insulation performance. So you should always pay attention to the glass, frame and installation detailing – not to forget the roller blind box. This must also be airtight and properly constructed so as not to form a weak point through which noise can penetrate to the inside.

When is it useful to measure sound insulation?

The acoustic quality of a building is one of the key criteria in housebuilding. That is why I always recommend proper acoustic design for new-builds and, above all, for refurbishments. This allows real improvements to be made – and not just by rule of thumb, but based on reliable technical principles. The required sound levels are calculated room by room and the windows selected accordingly.



Tight-fitting design and expertly installed: with 32 to 47 dB, our standard windows always offer outstanding sound insulation.

Tightness

→ Windows, sliding/folding

Reliable protection against air and water.

There are plenty of things a good window has to keep out. To do this, it must above all be weather-tight. Standard for Finstral: a range of features that enable our windows to offer an ever-reliable and long-lasting seal.



Always welded corners.

Airtight and watertight welded corners are standard for uPVC windows. As Finstral windows have a uPVC core in every material, they are always welded. This is offered by no other aluminium or wood-aluminium window.



Barrier-free, but weathertight.

Good tightness is becoming ever more important given the increasing frequency of severe weather events. That is why even Finstral's wheelchair-accessible, 2 cm flat thresholds offer class 9A driving rain tightness.



Tested and certified.

Finstral regularly subjects its window units to functional endurance tests in its own laboratory. All characteristic values are determined by means of independent external tests, e.g. at the Institut für Fenstertechnik (ift) Rosenheim.

System	Driving rain tightness	Air permeability	Resistance to wind loads (1-sash)	Resistance to wind loads (2-sash)
FIN-Window	Class 9A	Class 4	C5/B5	C4/B4
FIN-Window with parallel sliding-tilting hardware	Class 9A	Class 4	C5/B5	C3/B3
FIN-Project	Class 9A	Class 4	C4/B4	C2/B3
FIN-Slide	Class 6A	Class 4	npd	npd
FIN-Scroll	Class 5A	Class 4	npd	npd
FIN-Fold	Class 4A	Class 3	npd	npd
FIN-Vista	Class 9A	Class 4	npd	npd

Not to be taken for granted with modern windows, but standard at Finstral: our design features for optimum tightness. Pictured here: FIN-Window Classic-line uPVC-uPVC installed with the FIN-Fix mounting frame, with integrated thermally insulated aluminium windowsill.

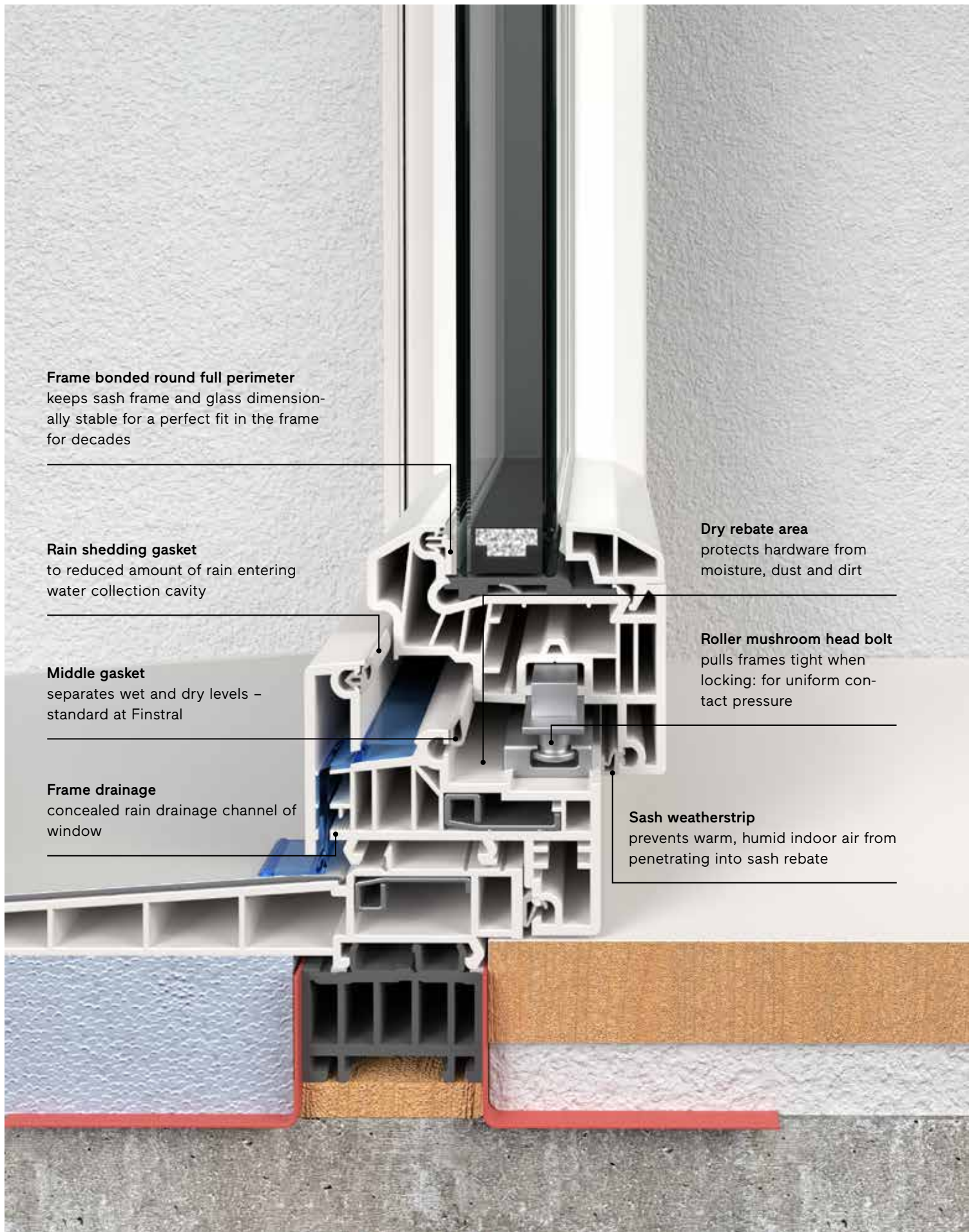

Centre → Building connection Smart installation in reveal.



Mounting method Sealing



Mounting method → New-build/refurbishment

Smarter methods of window installation.

Perfect installation requires good-practice, defect-free workmanship. If possible, finished windows should not be the first building elements to be completed and in place on site. Where this is the case, they are exposed to the risk of soiling, damage, building moisture and glass breakage. In line with the recommendations of the Institut für Fenstertechnik (ift) Rosenheim in the RAL Guideline (“Guideline for installation of windows and external pedestrian doors”), we therefore recommend two-stage installation with mounting frame, in preference to the traditional procedure, as the best window installation method.

Two-stage window installation with mounting frame for new-build: the frame is fitted during the wet construction phase, with the window itself not inserted until the dry phase.



Two-stage installation with mounting frame**Single-stage installation on masonry**

Availability of spaces	Irrelevant for new-builds	Irrelevant for new-builds
Protection of window against damage	No protection needed as window is not installed until after wet construction phase.	After installation, windows require protection against moisture, dirt and impact on wet construction site. Damage frequently occurs during wet construction phase.
Detailed design of building connection	Building connection library with over a thousand detail drawings, more than 400 of which have been tested by independent Institut für Fenstertechnik (ift) Rosenheim	Building connection library with over a thousand detail drawings, more than 400 of which have been tested by independent Institut für Fenstertechnik (ift) Rosenheim
Involved trades	Window installers as well as bricklayers, painters and, in some cases, scaffolders	Window installers as well as bricklayers, painters and, in some cases, scaffolders
Installation time per window*	Approx. ¾ hour for frame installation × 1 person, in addition adjoining trades + approx. ½ hour for window installation × 2 persons	Approx. ¾ hour × 2 persons, in addition adjoining trades, e.g. protection/masking windows
Coordination of installation	Low effort as installation is performed independently of other trades on site and offers clear interfaces for connections with their works. Avoidance of any delays in construction programme caused by window installation.	High effort as installation requires coordination with other trades on construction site. Delays or unforeseen circumstances must be accommodated.
Restrictions	No restrictions	No restrictions
Sustainability of installation	Perfectly prepared for straightforward window replacement in future	Not prepared for straightforward window replacement in future

* Including site set-up, manoeuvring of window, formation of building connection, installation of 1.40 × 1.40 m double-sash window on ground floor

Mounting method for new build/refurbishment → Two-stage installation with mounting frame

First-fix frame with windows fitted later.

Windows can be installed just as intelligently as light switches or taps: a frame is mounted as a first fixing during the wet construction phase. The finished window is then only fitted when all “messy” operations have been completed. This eliminates the risk of damage to the window while simplifying building operations.



a

The FIN-Fix mounting frame is fitted to the structural fabric. Not only does this prepare for installation of the window, the frame can also be factory-fitted with accessories for roller shutters, electricals, ventilators and the like.

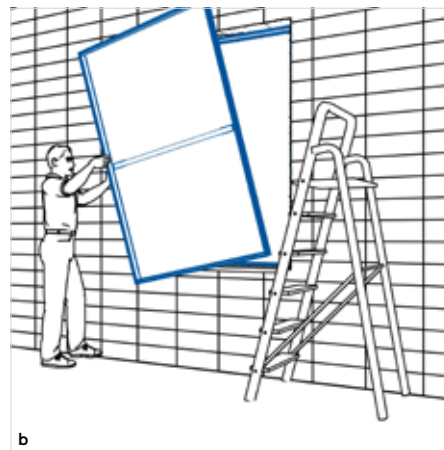

b

The reveal remains exposed during the wet construction phase so as to optimise ventilation of the structural fabric. As an option, the opening may be temporarily closed off with wind sheeting.



c

For the ongoing works on site, the frame then constitutes a clear-cut interface for subsequent trades, e.g. a precise edge for junctions with render/plasterwork.

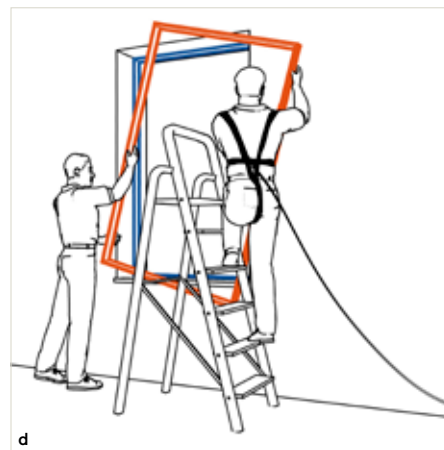

d

The finished window is not fitted until the dry construction phase, i.e. after all “messy” operations have been completed. This virtually eliminates the risk of damage.

Under the RAL Guideline, two-stage installation with mounting frame is recommended as the best installation method for windows and doors.

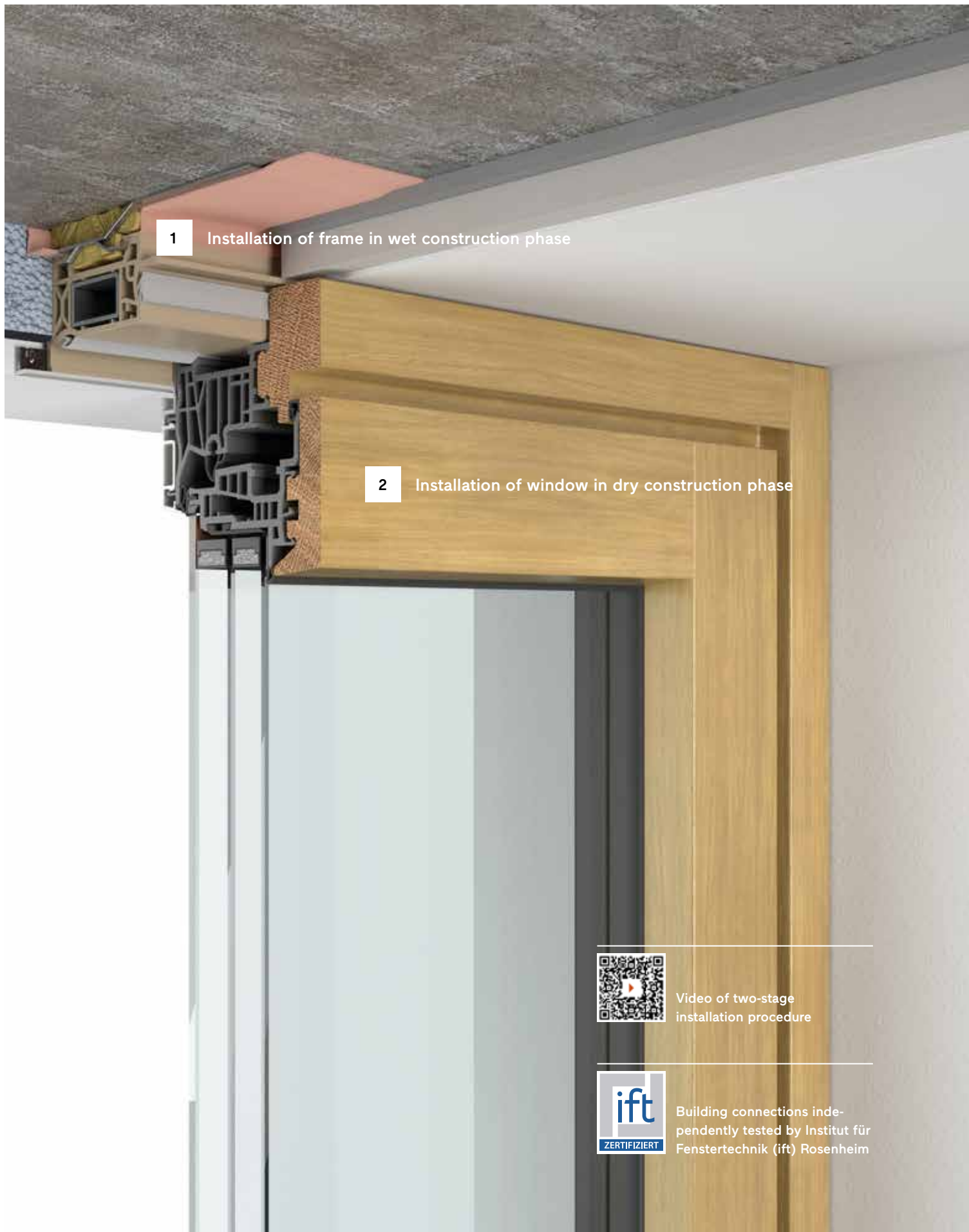

1 Installation of frame in wet construction phase

2 Installation of window in dry construction phase



Video of two-stage
installation procedure



Building connections inde-
pendently tested by Institut für
Fenstertechnik (ift) Rosenheim

Mounting method for new build/refurbishment → Single-stage installation on masonry

The traditional mounting method – with units requiring protection during construction phase.

The direct installation of windows in masonry is only ostensibly cheaper. It often happens that the new windows are damaged or soiled during the wet construction phase. Finstral recommends two-stage installation with the FIN-Fix mounting frame.



a

The frame is installed in the reveal during the structural works or so-called wet construction phase.

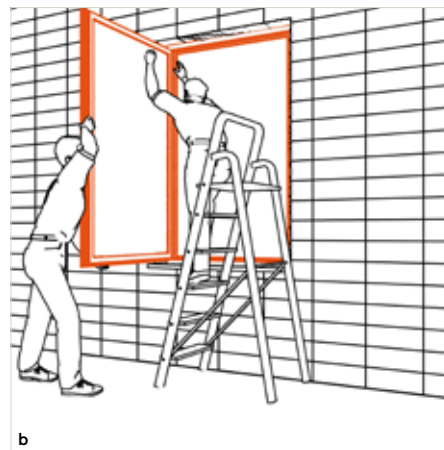

b

The window sash is then fitted in the frame, thereby closing off the building interior.

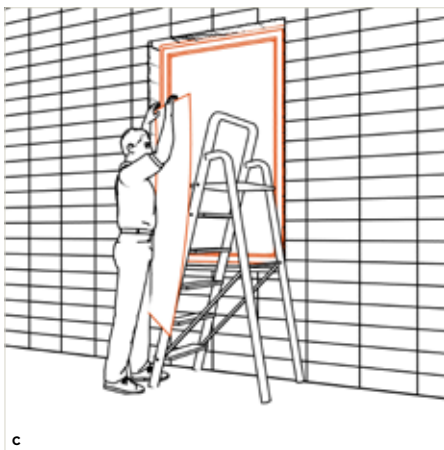

c

The installed window then requires protection, e.g. by means of protective sheeting, to prevent damage during the wet construction phase.

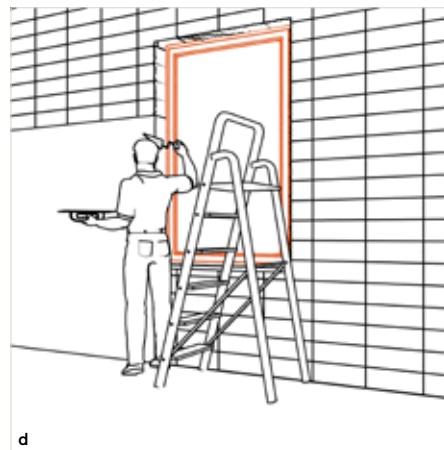

d

Following window installation, the wet construction works continue. These involve the indoor/outdoor application of plaster/render around the window.

To prevent damage to the window during the wet construction phase, we recommend the use of a mounting frame for installation.



1 Installation of frame in reveal

2 Protection of window against dirt and damage during wet construction phase

Mounting method → Refurbishment/replacement

Window replacement also easier.

Fast, clean, noiseless – and, above all, defect-free. That is how the perfect window replacement should be. To complement the traditional method of removal and reinstallation, Finstral offers a range of minimally invasive procedures that significantly reduce the effort required for refurbishment.

Window replacement with dismantling and reinstallation



Availability of spaces

As the existing frame is broken out of the reveal, not only the windows but also the interior spaces require protection against dust and dirt.

Protection of window against damage

No protection needed as no more dirt and dust arise after installation.

Detailed design of building connection

Building connection library with over a thousand detail drawings, more than 400 of which have been tested by independent Institut für Fenstertechnik (ift) Rosenheim

Involved trades

Window installers as well as, in some cases, bricklayers, painters and scaffolders

Installation time per window*

Approx. 1 ¾ hours × 2 persons, in addition adjoining trades, e.g. making good reveal plasterwork

Coordination of installation

Increased effort if other trades require coordination. Delays or unforeseen circumstances must be accommodated.

Restrictions

No restrictions

Sustainability of installation

Increased effort due to intervention in building fabric. No provision for simplifying window replacement, though refurbishment through slide-on or slide-in installation easier in future.

Window replacement on existing frame



The interior is soon reusable as the replacement can be carried out quickly and without dust or dirt. Only the surface in front of the window needs cleaning.

No protection needed as no more dirt and dust arise after installation.

Building connection library with over a thousand detail drawings, more than 400 of which have been tested by independent Institut für Fenstertechnik (ift) Rosenheim

Window installers only

Approx. 1 ¼ hours × 2 persons, no adjoining trades needed

Flexible, as independent of other trades. Low risk of unforeseen circumstances allowing more reliable estimation of effort.

Only feasible if existing frame in place

Resource-efficient treatment of existing building as no intervention in building fabric needed. Perfect preparation for straightforward window replacement in future.

Window replacement with slide-on installation on existing wooden frame



The interior is soon reusable as the replacement can be carried out quickly. As the existing wooden frames are cut back, floors and furniture require protection against dirt.

No protection needed as no more dirt and dust arise after installation.

Building connection library with over a thousand detail drawings, more than 400 of which have been tested by independent Institut für Fenstertechnik (ift) Rosenheim

Window installers only

Approx. 2 hours × 2 persons, no adjoining trades needed

Flexible, as independent of other trades. Low risk of unforeseen circumstances allowing more reliable estimation of effort.

Existing wooden frame undamaged

Resource-efficient treatment of existing building as no intervention in building fabric needed. Straightforward window replacement feasible in future through renewed slide-on installation.

Window replacement with slide-in installation on existing aluminium or uPVC frame



The interior is soon reusable as the replacement can be carried out quickly and without dust or dirt. Only the surface in front of the window needs cleaning.

No protection needed as no more dirt and dust arise after installation.

Building connection library with over a thousand detail drawings, more than 400 of which have been tested by independent Institut für Fenstertechnik (ift) Rosenheim

Window installers only

Approx. 1 ¼ hours × 2 persons, no adjoining trades needed

Flexible, as independent of other trades. Low risk of unforeseen circumstances allowing more reliable estimation of effort.

Not feasible in case of flush installation of existing window in reveal
Nova-line frameless sashes are recommended to preserve external appearance.

Resource-efficient treatment of existing building as no intervention in building fabric needed. Straightforward window replacement feasible in future through renewed slide-in installation.

* Including protection of interior, manoeuvring of new window, dismantling of old window, installation of new window with building connection, manoeuvring of existing window, for 1.40 × 1.40 m double-sash window on ground floor

Mounting method for refurbishment

→ Window replacement through dismantling

The traditional method.

The existing frame is not torn out, but very carefully dismantled. Damage to adjoining building elements and finishes can be largely avoided. Particular care must also be taken to minimise the creation of dust and dirt so as to limit the impact on the furnished living environment.

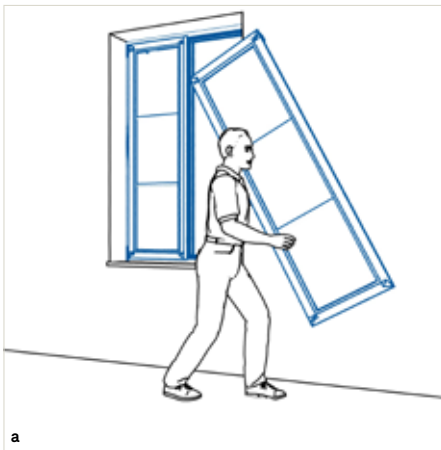

The old sash frame is removed and, if required, taken away by the installer for proper recycling.

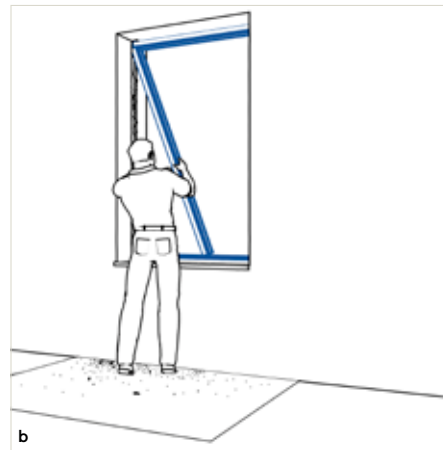

The existing frame is broken out of the reveal.



The reveal is made good on the inside and outside (by plastering/ rendering and painting). Scaffolding is used where necessary.

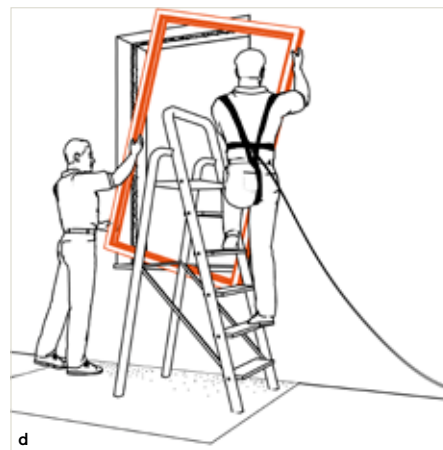

The new frame is installed in the reveal. The new sash can then be fitted.

The complete removal of the existing frame involves increased effort due to the intervention in the building fabric.



Mounting method for refurbishment

→ Window replacement on existing frame

So quick, so easy.

Were your existing windows fitted on a mounting frame? Then you are in luck because this makes window replacement child's play. The old window is unscrewed from the frame and a new one inserted. The replacement can be performed at a rate of around one hour per window, without noise, dirt, scaffolding or any need for users to vacate the building.

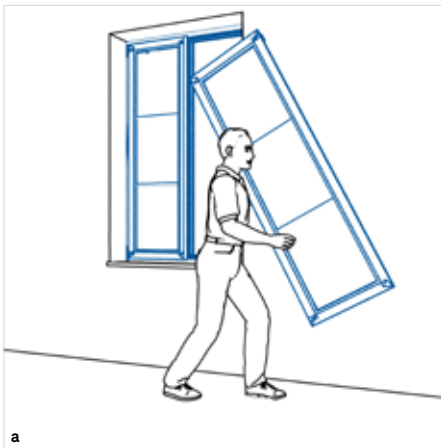

a
The old sash frame is removed and, if required, taken away by the installer for proper recycling.

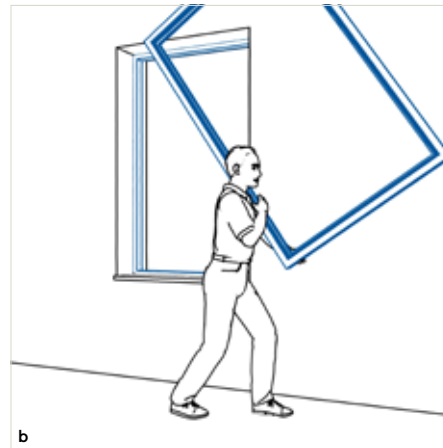

b
The existing frame is unscrewed from the mounting frame and removed. This generates hardly any noise or dirt.

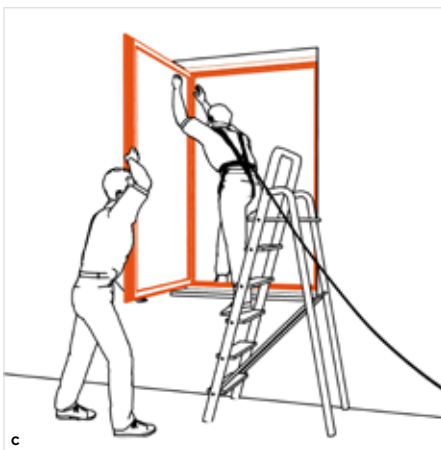

c
The new frame is inserted into the existing mounting frame and screwed down. The sash can then be fitted in place.

If a mounting frame is already fitted, then the window can be replaced in around one hour.



1 Remove the old frame from the mounting frame

2 Screw the new frame to the existing mounting frame

Mounting method for refurbishment

→ Window replacement with slide-on installation

Effortless refurbishment of old wooden windows.

Slide-on installation is the best option for wooden windows. This process was pioneered by Finstral and has been applied since 1978. It involves cutting back the existing wooden frame to just a few centimetres and sliding on the new frame. The replacement can be performed at a rate of around two hours per window, without any masonry or painting works or any need for users to vacate the building.

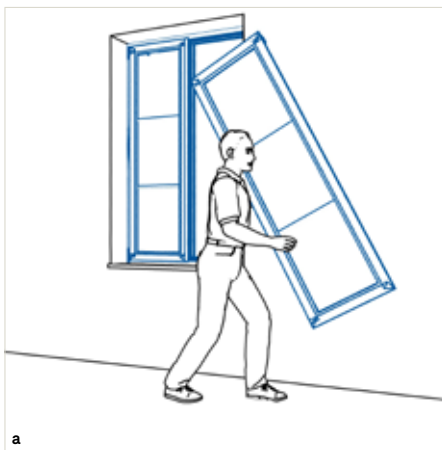

The old sash frame is removed and, if required, taken away by the installer for proper recycling.

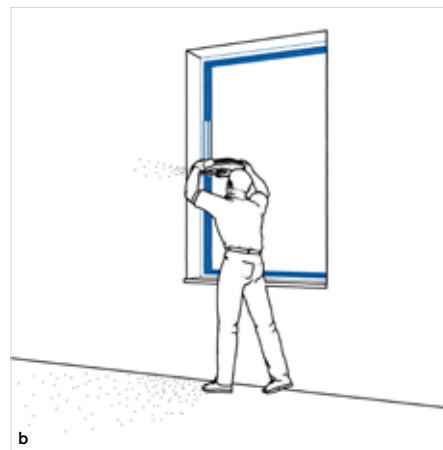

The hardware is removed from the old wooden frame, which is then cut back to a thickness of just a few centimetres. This may create a slight amount of dust.

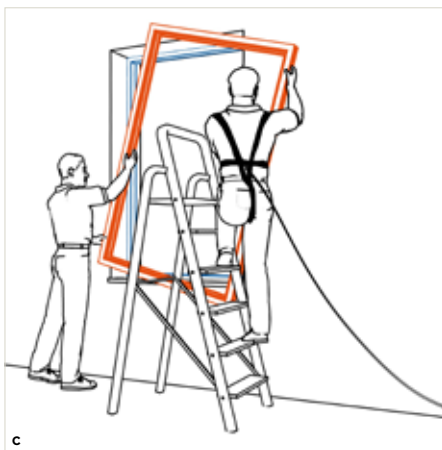

The new frame is then simply slid on and screwed to the existing frame.

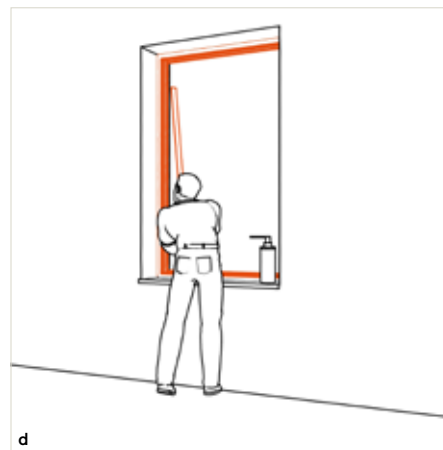

The old wooden frame is externally faced – and simultaneously protected against weathering. The sash can then be fitted in place.

Finstral slide-on installation: minimally invasive, dirt-free and without intervention in masonry.

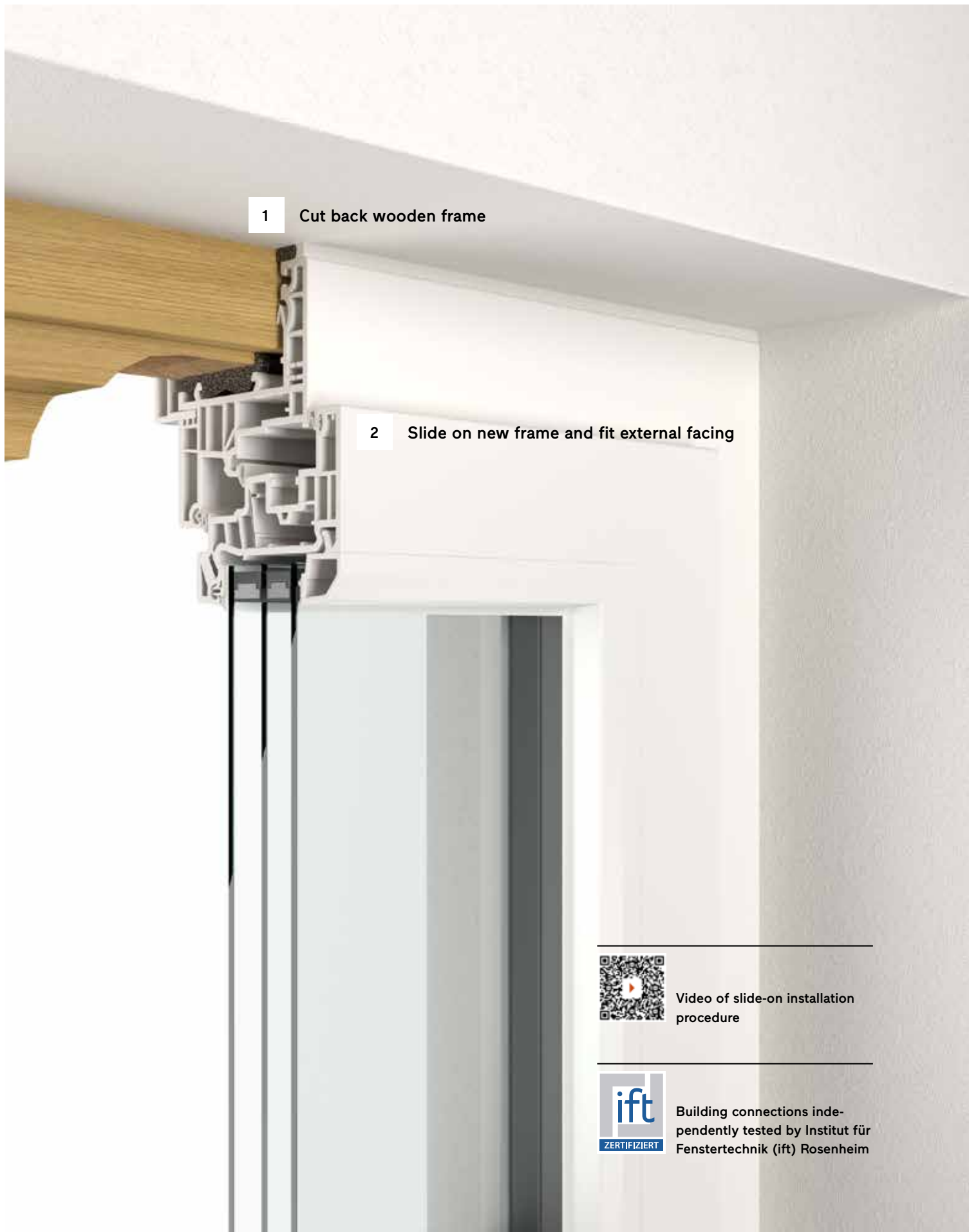

1 Cut back wooden frame

2 Slide on new frame and fit external facing



Video of slide-on installation procedure



Building connections independently tested by Institut für Fenstertechnik (ift) Rosenheim

Mounting method for refurbishment

→ Window replacement with slide-in installation

Effortless refurbishment of uPVC or aluminium windows.

Slide-in installation is recommended for uPVC or aluminium windows. Here, the existing frame is retained and faced by a new one. Given that the newly inserted sash is frameless, there is no change to the look of the exterior. The replacement can be performed at a rate of around one hour per window, without noise, dirt, scaffolding or any need for users to vacate the building.

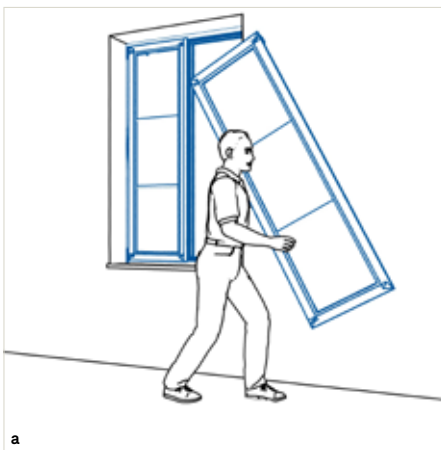

a The old sash frame is removed and, if required, taken away by the installer for proper recycling.

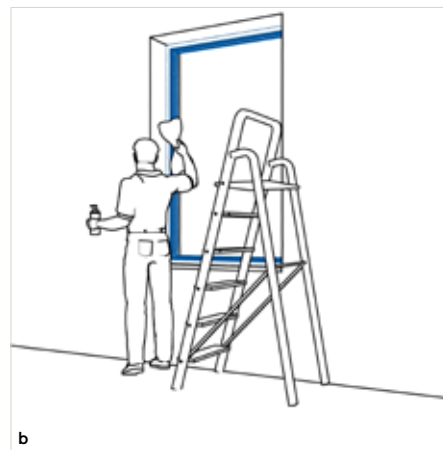

b The hardware is removed from the old frame, which is then professionally cleaned on both inside and outside. This generates neither noise nor dirt.

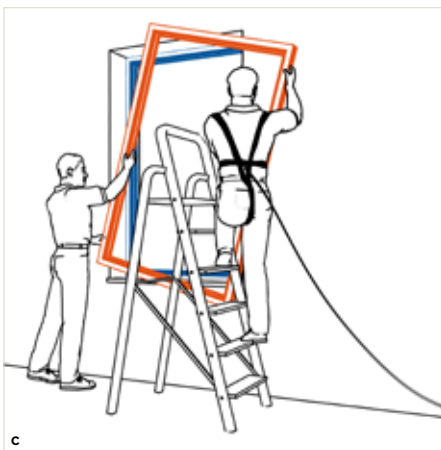

c The existing frame is faced by a new frame profile and thereby additionally insulated.

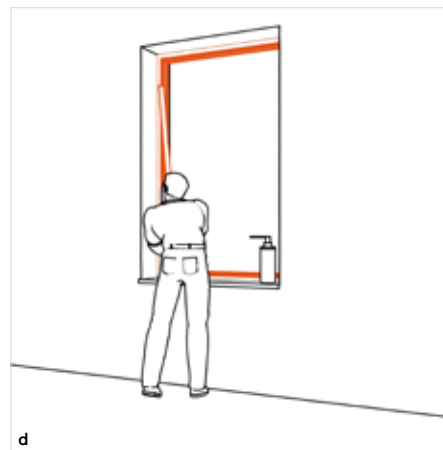

d Where necessary, trim can be fitted on the interior to provide a neat look. The sash can then be fitted in place.

As the existing frame is internally faced, slide-in installation is unsuitable for windows installed flush on the interior.

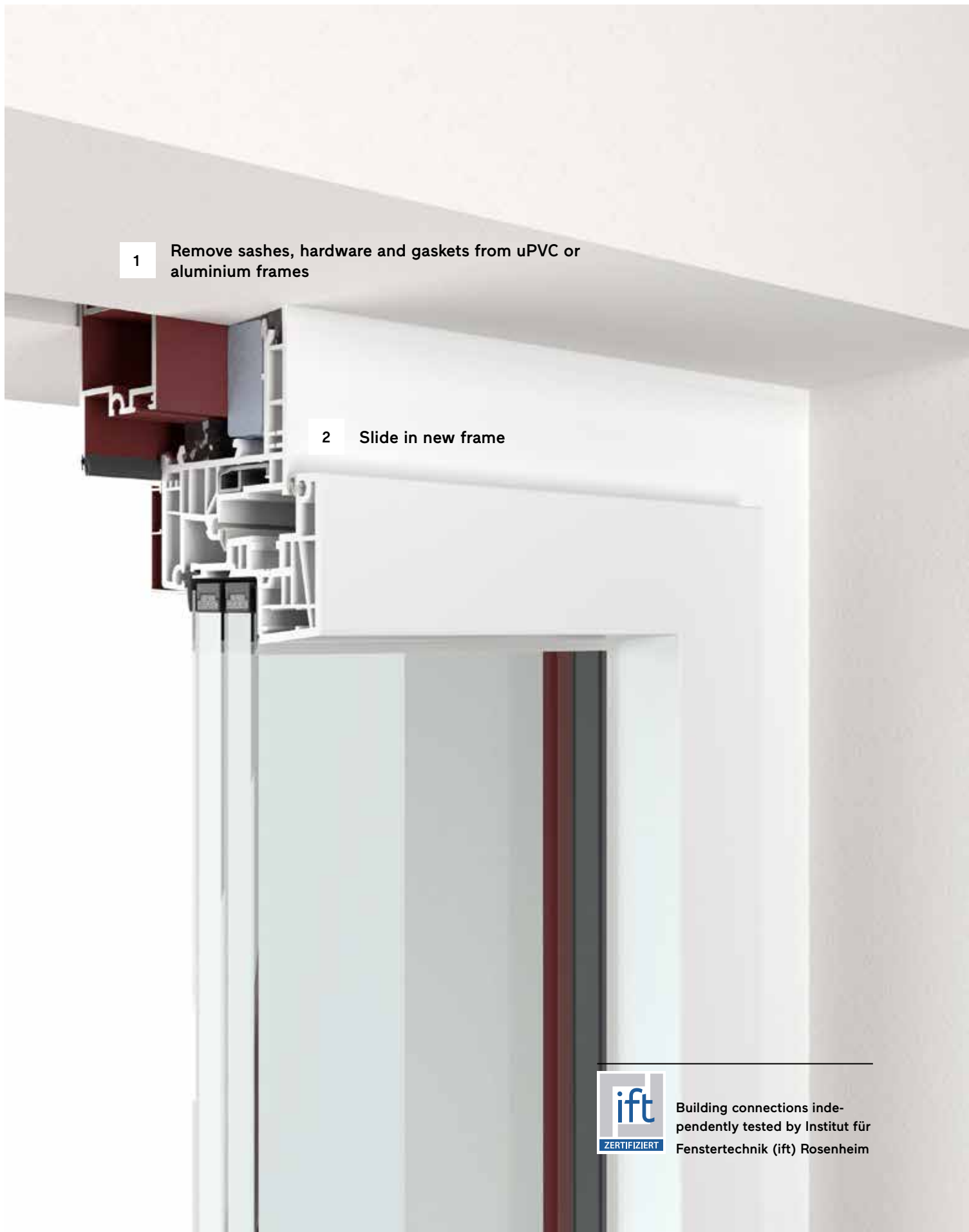

1

Remove sashes, hardware and gaskets from uPVC or aluminium frames

2

Slide in new frame

Replacing decades-old windows by new ones always brings a host of benefits – e.g. greater comfort, effective sound insulation, a more appealing design ... and above all: an appreciable cut in energy costs due to better insulation. The best news comes from Finstral: our minimally invasive mounting methods allow windows to be replaced in record time – without residents having to vacate their homes, without construction noise and dirt, without scaffolding, and without any masonry and painting works. In an interview, Finstral expert Timo Sachse explains the exact procedure.

“The phrase ‘in next to no time’ was invented for this.”

Against the backdrop of the climate crisis and high energy costs, the debate about modernizing heating systems is very much on the agenda. But what about windows?

They are everywhere. We don't have to go down into the basement to find them. But, amazing though it is, they are still far too often overlooked. Naturally enough, the type of heating system, i.e. the means of energy generation, is very important. But the most sustainable energy of all is and remains that which is not consumed in the first place. And this is where Finstral's modern, perfectly insulated windows come in: not only do they cut carbon emissions, they also save money that would otherwise, quite literally, be thrown out of the window.

So window refurbishment really does make sense in terms of energy efficiency. But surely the replacement operation itself is expensive, elaborate and time-consuming ... and requires well-insulated nerves, doesn't it?

Not when Finstral installs new windows. It's practically child's play ... OK, windows are a bit too heavy for toddlers. (Laughs.) We prefer to use the expression “minimally invasive” to describe our methods.



Timo Sachse has been working at Finstral for nearly 30 years and has been a window enthusiast for at least that long. As Head of Technical Sales, he particularly enjoys handling large-scale and complex refurbishment projects.



Some 1,400 windows, 3 months, 6 installers: a refurbishment scheme for three apartment buildings in Erfurt demonstrates how Finstral's slide-in installation technique radically simplifies the replacement of old windows.

thoroughly cleaned. The new frame then slides into the existing one and is screwed down. And, for the sake of completeness, I should point out that, if the old window itself was installed in two stages, i.e. with a mounting frame built into the masonry, we can reuse this. In such cases, the old frame is simply unscrewed from the mounting frame and the new one screwed on. Of course, whatever model is being installed, the new window sash with the glass is fitted and everything perfectly adjusted at the end ... And two window installers always suffice! The building occupants waiting in the adjoining room hardly notice them. And wonder why they disappear again so quickly.

“Minimally invasive”? That sounds like medicine and surgery ...

Exactly. Doctors endeavour to use surgical techniques that do as little damage as possible to human tissue. Similarly, our ambition is to leave the masonry untouched when replacing windows. Because knocking open walls immediately involves time, effort and cost while causing noise and dirt. Plus you then have to rely on bricklayers and painters, in other words commission other tradespersons. In the vast majority of cases, you also need scaffolding. The affected residents have to move out and the neighbours get annoyed. All a big nuisance. Minimally invasive procedures, on the other hand, are low-impact – and faster. In both the operating theatre and on building refurbishment projects.

But how can that be done? Windows are built into the masonry, aren't they?

Of course they are – and that's the way they stay when we have refurbished them. Put simply, the ingenious trick behind Finstral's installation method is to leave in place the built-in part of the old window – i.e. the existing frame. And simply to use it, so to speak, as a “support” for the new window. Now if that isn't sustainable!

So does that mean my new Finstral window won't have a new frame?

Of course it will ... and a premium-quality one! This is the only way our windows can meet the highest standards of insulation, security, soundproofing and so on. But we dispense with the laborious process of breaking out the old frame and plastering in a new one. No, we simply slide the new frame onto the old one and connect the two.

How exactly?

The particular details depend on the original window, but the principle always remains the same. We cut back old wooden frames, slide the new frame onto this and screw it down. This is called “slide-on installation”. Our “slide-in installation” technique is used for existing uPVC or aluminium frames: after we have removed all the hardware, these are

And why is that? How long does the replacement take?

For slide-on installation, roughly two hours per window. For slide-in installation or fitting to a mounting frame, around one hour. The phrase “in next to no time” was invented for this. Nor should we forget that, in the course of replacing the windows, we naturally also reinstate the building connections.

The mechanics of a window replacement sound almost too good to be true. But what about the final appearance? Often, this should or must not change significantly on the exterior ... while, in the interior, the occupants may appreciate new colours or a different material.

I'm glad you asked that. With slide-in installation, the old frame remains visible on the outside: if our frameless Nova-line window sash is incorporated, you will not notice any difference in the façade composition! On the inside, however, you enjoy the full design freedom offered by our modular window range. With frames in uPVC, aluminium, glass or real wood? Even ceramics or alternative metals can be selected. Complemented by an elegant window handle. This vastly enhances the quality of the interior. In terms of functionality too, a wealth of options are available. With innovative shading devices in the coupled sash. Or with lightweight solar protection glass to prevent rooms from heating up. And so on ...

But if windows are suddenly much better insulated than before, don't you have to worry about mould growth?

Not if you simultaneously ensure controlled interior ventilation. Provision for this can be made by integrating the necessary features directly in the window frame. These cannot be seen or otherwise noticed, but nonetheless deliver the necessary air change.

Brand-new, more attractive, more weatherproof, more modern, offering ventilation, and quick and easy to put in place. Who can say no to windows like that?

Only burglars. (Laughs.) Because, naturally enough, new Finstral windows offer a high level of security.

Mounting method → Shading device boxes

Solar protection, always professionally installed.

Three different installation options are available for roller shutter boxes to suit the needs of the particular construction project. External Venetian blinds and fabric shades, on the other hand, are always fitted with our pre-installed mounting frame.

Roller shutter

Refurbishment.

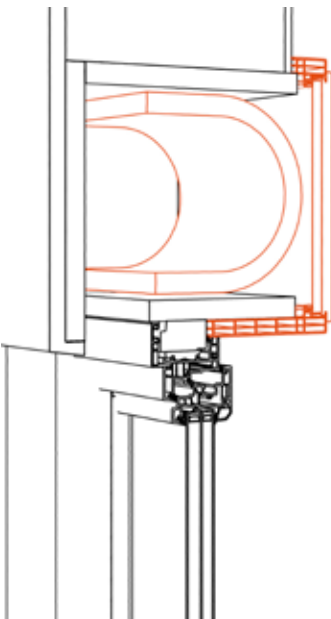

- A flexible insulation insert is fitted in the existing roller shutter box.
- The refurbished roller shutter box has a thermal transmittance of $U_{sb} 0.67 \text{ W/m}^2\text{K}$.
- Fixed roller shutter boxes built into the masonry can be clad in the same colour as the window and thereby additionally insulated with little effort and expense.

Traditional installation.

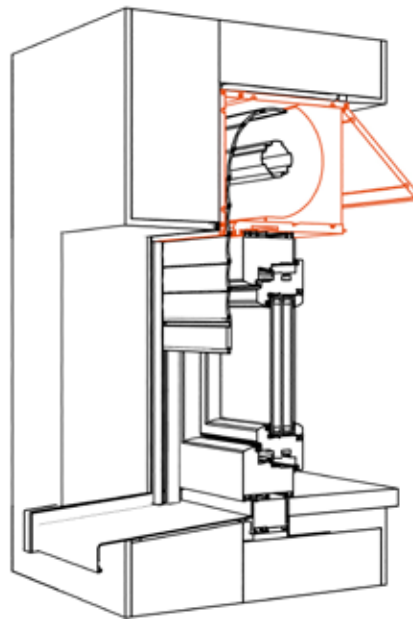

- Outward-rolling shutter curtain
- Service cover inside or, optionally, inside at bottom
- Attached box is insulated such that no heat or cold is lost.
- Cleaning and maintenance: box can be opened via service cover fitted on inside.

Contemporary installation.

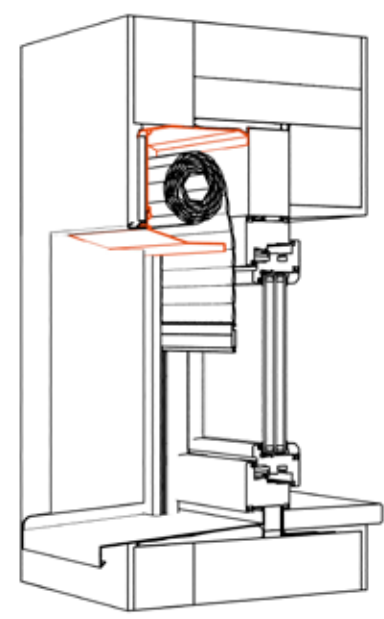

- Inward-rolling shutter curtain
- Virtually invisible service cover on outside
- Externally mounted in front of window, roller shutter box needs no separate insulation; if required, can be concealed below plaster.
- Maximum aesthetic appeal inside: box completely invisible from living area

Innovative installation

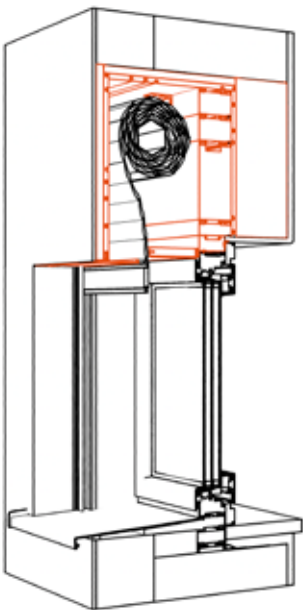

- Outward-rolling shutter curtain
- Virtually invisible service cover on outside
- Roller shutter box is fitted on mounting frame
- Window, shutter curtain and guide rails are fitted after construction works to prevent damage and soiling.
- Optionally combinable with insect screen and integrated motorised ventilator

External Venetian blinds

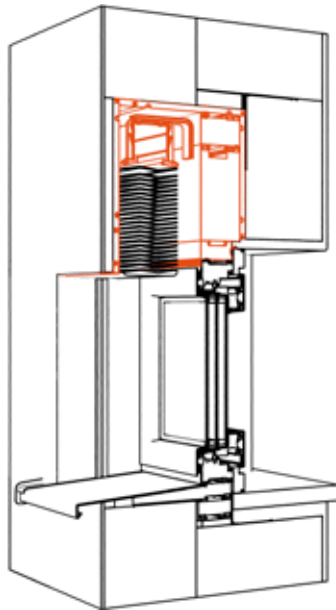

- Fully pre-installed mounting frame is fitted along with box, which is concealed behind render.
- Window, slats and exposed guide rails are fitted after construction works to prevent damage and soiling.
- Optionally combinable with insect screen and integrated motorised ventilator

Fabric shade

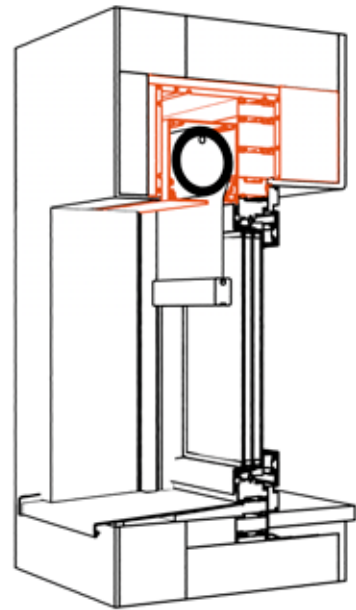

- Pre-installed mounting frame along with box is fitted and rendered over during wet construction phase.
- Window and shade are added during dry construction phase to prevent damage and soiling.

Mounting method → Hinged shutters

Always with a suitable installation option.

There are various methods of fitting traditional hinged shutters: we offer four different options to meet your wishes – be it to uphold the regional tradition or create a distinctive façade.

Hinged shutter

Installation with attached frame

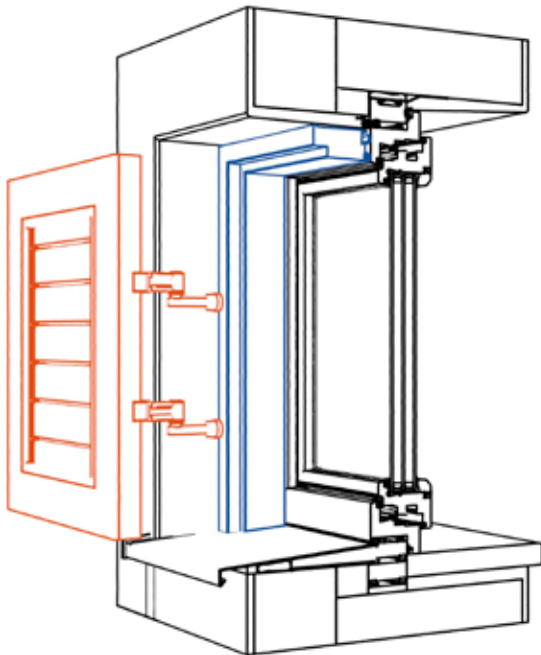

- The hinged shutter is fixed to the wall with its own attached frame.
- The attached frame partly or completely covers the reveal.
- The attached frame is only available in uPVC.

Installation with reveal frame

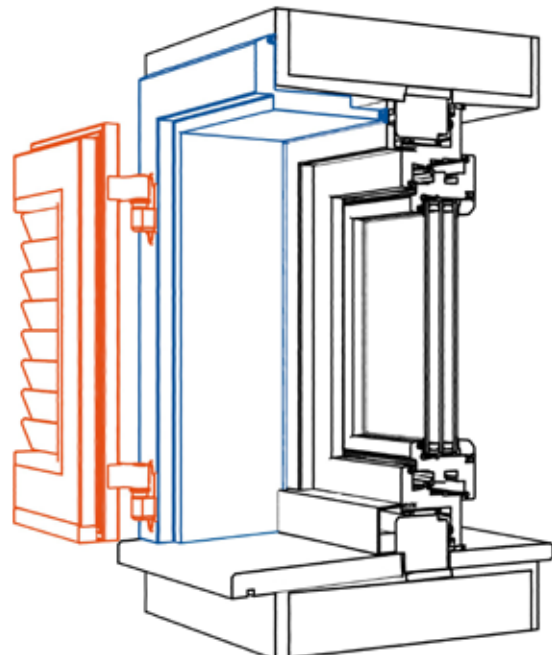

- The hinged shutter is fixed to the wall with its own reveal frame.
- The reveal frame covers the entire reveal and edge of the wall.
- It is available in three versions:
 - Reveal frame made of steel-reinforced uPVC
 - Reveal frame made of aluminium with uPVC facing
 - Reveal frame made of pure aluminium

Installation directly on block frame

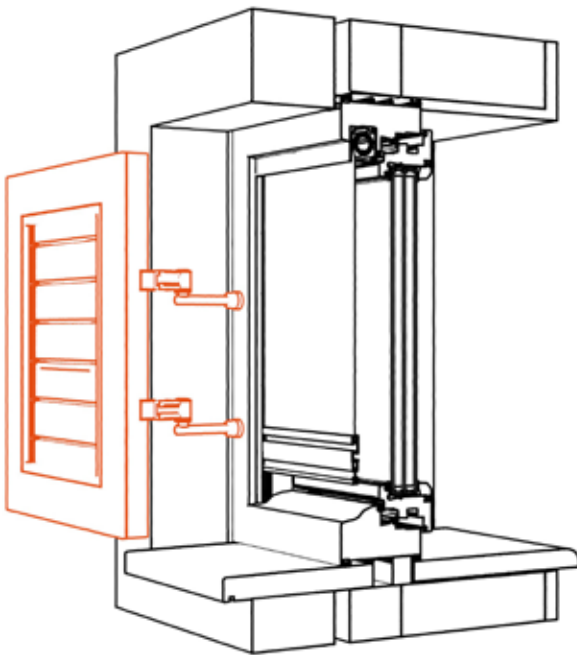

- The hinged shutter is fixed to the block frame of the window without any additional frame.
- Only suitable for uPVC block frames

Installation directly on masonry

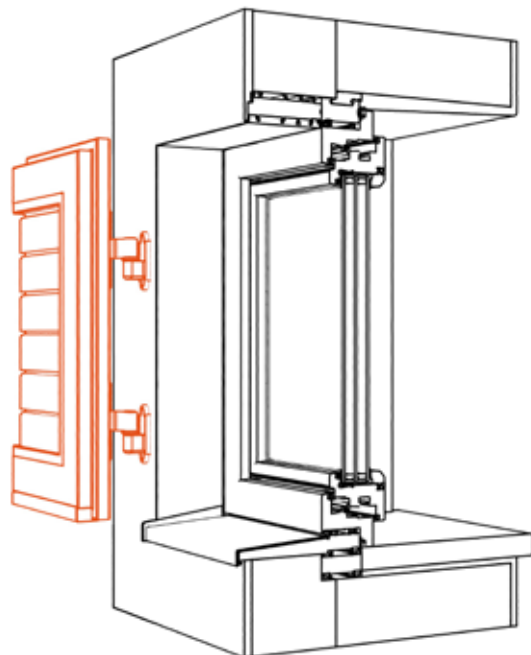

- The hinged shutter is fixed directly to the wall without any additional frame.
- The hinged shutter can be installed flush with or proud of the external wall.

Mounting method → Window wall

Straightforward and meeting the highest standards.

Compared to traditional stick (mullion/transom) systems, FIN-Vista window walls are uncomplicated and quick to install. This is because we prepare all components, as far as possible, in our factory and ensure clean, safe and reliable installation to the highest standards.



Reduced complexity on site.

With a standard window wall, each mullion and transom is individually assembled on site. With FIN-Vista, on the other hand, we deliver factory-pre-assembled frame segments in extra-large sizes with our own flatliner trucks.



Bonded glass panes.

Once the FIN-Vista frame segments have been installed, the insulating glass panes are fitted directly on site – and, as always with Finstral, bonded around the perimeter rather than simply fixed with glazing blocks. This serves to stiffen the window wall assembly, which then remains permanently stable.



First the works, then the window frame.

To protect your new window wall during the construction phase, FIN-Vista is designed such that the interior facings are fitted only when all construction works have been completed. This prevents any damage to the facings while also allowing their replacement at any time.



Building connection: ift-tested.

For the window wall too, Finstral offers a comprehensive building connection library of detail drawings – many of which are ift-certified. Moreover, the experts from the Finstral Architect Service will help you clarify all other necessary details.

Thanks to the pre-assembled frame segments, FIN-Vista window walls can be readily installed in the mounting frame during the dry construction phase.

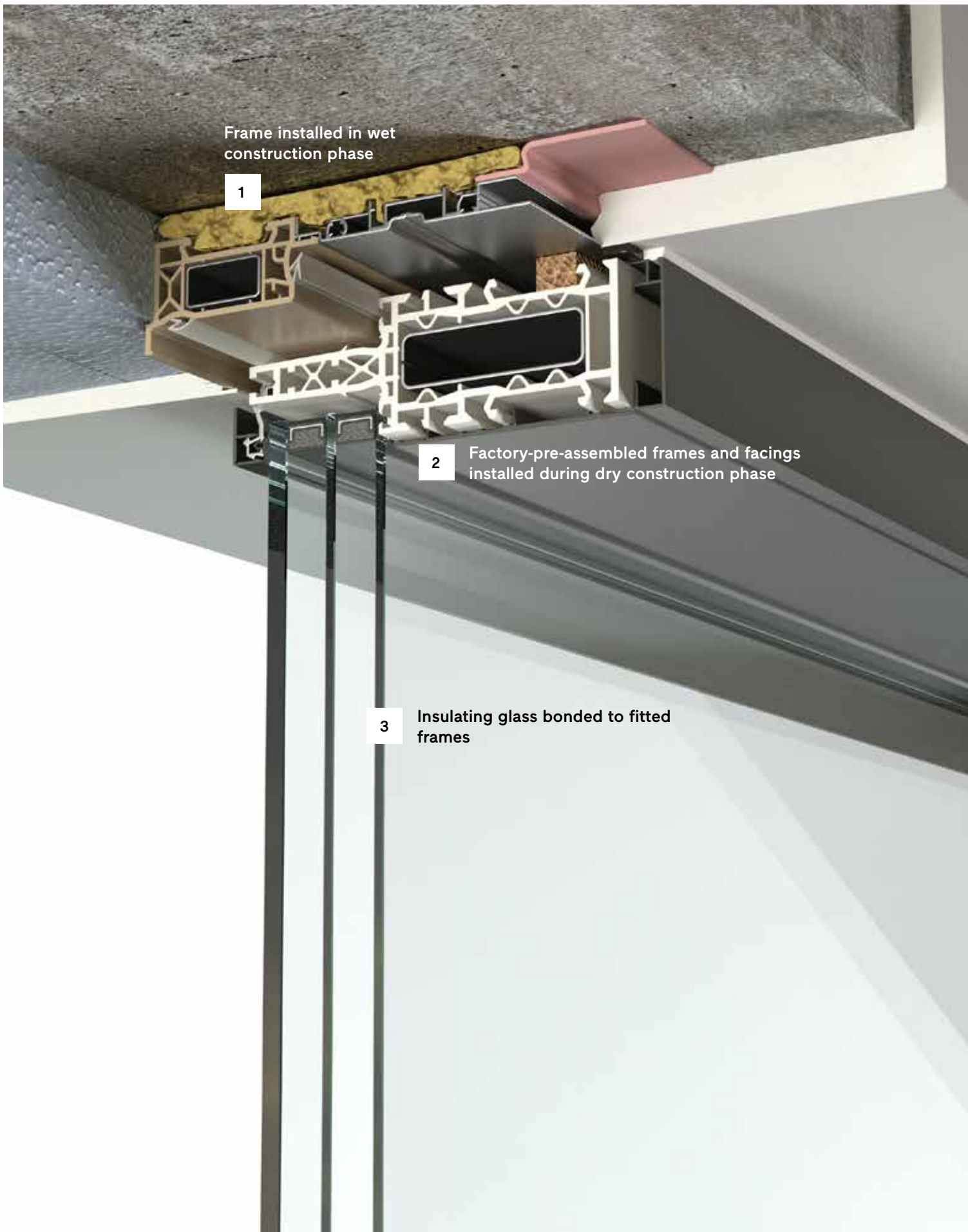

Mounting method → Models for the whole of Europe

Comprehensive building connection library.

Finstral offers a library with detail drawings of around 1,000 building connections from throughout Europe. They provide clear, intelligent specifications for fixing and sealing our building elements. This rules out any on-site experimentation and improvisation. Some 400 of our building connection drawings have been certified by the Institut für Fenstertechnik (ift) Rosenheim. Are you looking for a building connection solution? Please feel free to ask us at finstral.com/contact

Mid-wall installation

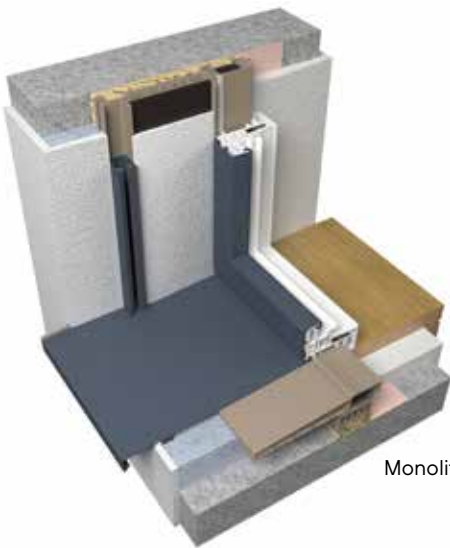

Monolithic masonry

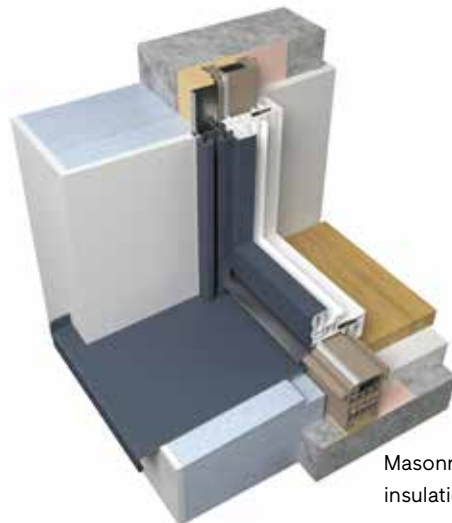

Masonry with external thermal insulation composite system



Masonry with external thermal insulation composite system;
pre-wall installation

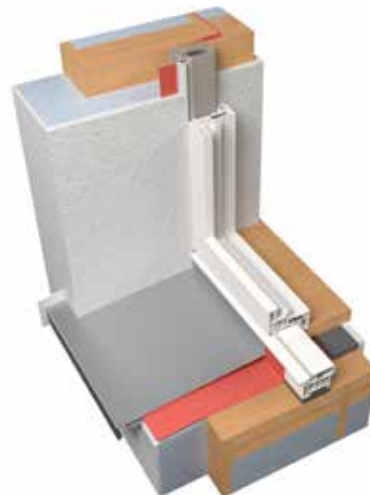

Timber stud frame

Installation flush on interior



Italy, Spain

Installation in cavity wall

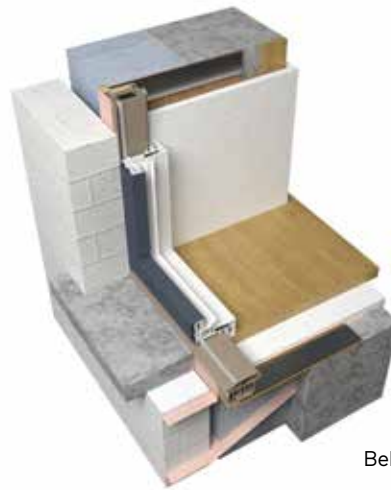

Belgium, northern Germany



France



Netherlands

Sealing

Only a properly fitted window can be perfect.

Expert installation is crucial for delivering an optimum seal, maximum thermal insulation and long-lasting user comfort. Your windows or doors are fitted in accordance with the official installation guidelines and certified building connection drawings.

Good-practice sealing is vital.

The basic principle behind sealing is to achieve a tighter seal on the inside than on the outside. This is because indoor air is warm and humid. To prevent it from diffusing into the building connection, this must be airtight on the inside. On the outside, by contrast, it must be vapour-permeable so as to allow moisture to evaporate.

Always clear-cut specifications.

Finstral offers a comprehensive building connection library with detailed descriptions of good window installation practice. Are you looking for a building connection solution? Please feel free to ask us at [finstral.com/contact](https://www.finstral.com/contact)

Trained installers.

You can rely on our consistently expert installation, independently certified by the Institut für Fenstertechnik (ift) Rosenheim and confirmed by annual quality audits. Look for this symbol.



 **FINSTRAL**

 Institut für
Fenstertechnik
Rosenheim
ZERTIFIZIERT

**Certified assembly
professional**

Single-stage installation directly on wall

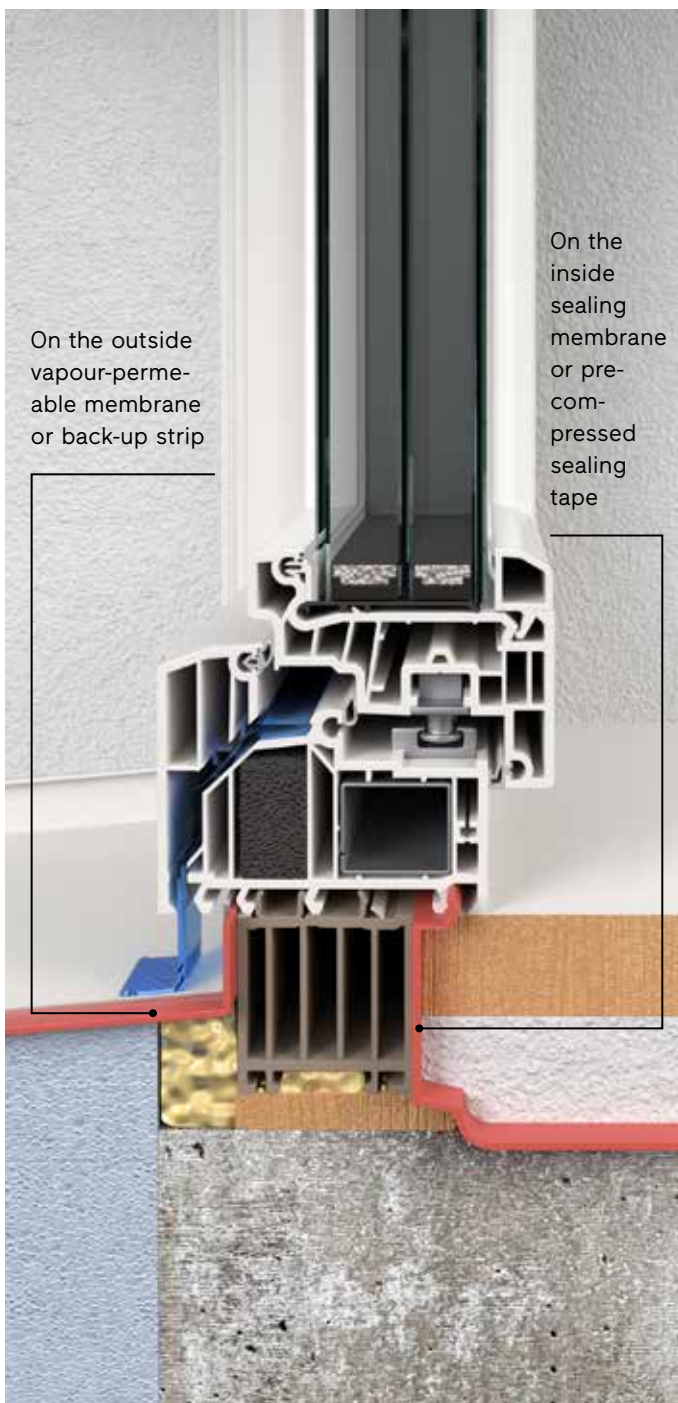

Two-stage installation with frame

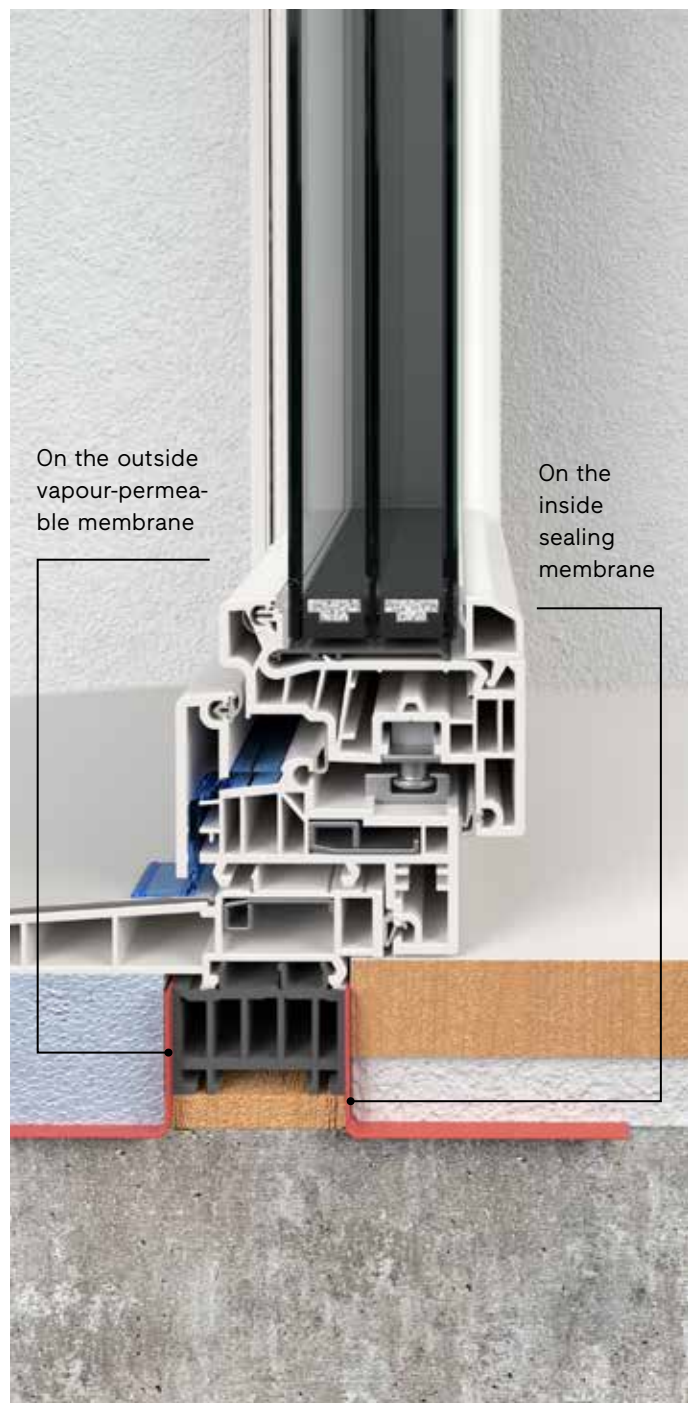

Interior → Design
Tailored to your
interior.



Material
Colour/Finish
Frame shape
Handles/Hinges
Accessories



Material

→ Frame and sash

Free choice of material.

How would you like to fit out your interior? What makes you feel at home? The window frame and sash material may rightly be considered part of the interior. After all, windows are more than just functional components. Finstral offers virtually endless design options with uPVC, aluminium, wood, frame-covering glass or inlay – each with its own special character.

Material properties of uPVC.

Particularly robust and easy-care, always through-coloured and with the high-quality Finstral finish. You can see and sense it – especially on the inside.

Material properties of aluminium.

The shimmering elegance of aluminium – which Finstral offers in an extremely wide colour range – adds a unique touch, also to living environments.

Material properties of wood.

Nothing feels more homely than real wood. Finstral offers naturally treated hardwood and softwood for interiors.

Endless options with inlay.

Your frame can be designed with inlays in virtually any material: metal, ceramics, precious woods ... The choice is yours.

Material combinations
for interior

Sash frame
uPVC

Window frame
uPVC



Window frame
Aluminium

Window frame
Wood

Window frame
Inlay

Sash frame
Aluminium

Sash frame
Enamelled glass

Sash frame
Wood

Sash frame
Inlay

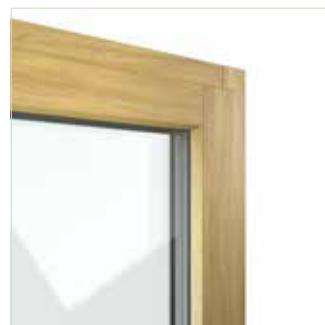
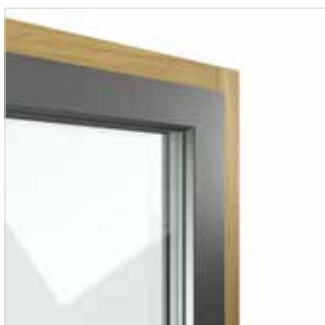

Exterior → Design →
Colour/Finish → Aluminium

Exterior → Design →
Colour/Finish → Enamelled glass

Interior → Design →
Colour/Finish → Wood

Interior → Design →
Colour/Finish → Inlay

Colour/Finish → uPVC

Easy-care with high-grade finish.

Whether smooth, embossed or with satin finish: our uPVC profiles are always properly compressed and the textures embossed into the material. This has the advantage of producing highly easy-care finishes with lasting appeal.

uPVC
from left to right:
01 White extra smooth
42 White embossed
45 White satin finish





Colour/Finish → Wood decor

Easy-care, long-lasting look of wood.

Whether uPVC or aluminium: our wood decors are hardly distinguishable to the eye from real wood while being easier to clean and less sensitive to moisture, scratches and dirt. For a pleasant, natural living ambience.



Wood decor
from left to right:

uPVC
19 Oak wood decor

Aluminium
L19 Oak coated wood
decor



Colour/Finish → Aluminium

Maximum variety.

Bright yellow or jet black, smooth or slightly grainy: our wide range of stylish, full-strength, special effect and special colours embraces some 250 tones that will enable you to tailor the inner face of your window to your exact wishes.

Aluminium
from left to right:
358 Gris
F905 Jet Black
fine texture
M118 Zinc Yellow matt





Colour/Finish → Wood

Authentic, warm, homely.

Unlike on the façade, solid wood that features in the interior, where it is protected from the weather, can bask in its unique aesthetic qualities for many years to come. Our hardwood and softwood options provide you with a wide choice.



Wood
from left to right
1X01 Spruce Nature
3X07 Oak White
open-pored
2X02 Oak Nature oiled



Colour/Finish → Wood

Naturally beautiful.

Real wood can offer a good match for diverse styles of furnishing, from traditional to contemporary. The oak used for our own production comes mainly from France, the spruce mainly from South Tyrol/Italy.

Softwood.

Sustainably produced spruce in natural colour or five classic shades.



Hardwood.

Extremely durable and high-quality as Oak Nature, Oak Nature oiled or seven contemporary colours.



In our own production facilities, we make facings from high-quality wood. This enables us to optimise the use of this precious raw material.



Colour/Finish

→ Inlay with precious wood, ceramics, metal

Variety to the power ten.

There is already a vast choice of materials for our window interiors: uPVC, aluminium and real wood in many varieties. Through adoption of an innovative technique, the number of design options can veritably skyrocket. This involves the use of a narrow aluminium support profile to hold a real wood, metal or ceramic inlay and thereby provide for virtually unlimited combinations.

Inlay from left to right:

Precious wood
7X01 Birch Nature oiled
with support profile in
aluminium F905 Jet Black
fine texture full-strength

Ceramics
7C09 Lava Corten with
support profile in alumin-
ium 2525 Mars special
effect colour

Metal
7M02 Brass patinated
with support profile in
aluminium LC33 Mid
Bronze special effect
colour





Colour/Finish

→ Inlay with precious wood, ceramics, metal

Blends with its surroundings – and adds accents.

What materials, colours and textures can a window frame feature? Thanks to inlay, Finstral can now offer many more answers to this question. Which, in turn, transforms the window into a defining element of the interior design. Either because the window and sash frames harmonise perfectly with the interior fittings and furnishings. Or because they provide eye-catching accents. Window and sash frames may even be configured independently of each other with different inlays or frame materials.

Inlay in 5 precious wood varieties.



Inlay in 5 metal varieties.



Inlay in 12 ceramic varieties.



Aluminium in 250 colours.

The support profile is available in all aluminium colours – all of which are factory-applied by Finstral.

Precious wood 7X05 American Walnut Nature oiled, Ceramics 7C15 Seta Glace, Ceramics 7C05 Oxide Black, Ceramics 7C12 Filo Ghisa, Metal 7M01 Brass satin finish.



Frame shape → Window frame

Classic look

Window frame offset from sash frame

Modern look

Window frame flush with sash frame

uPVC window frame



Aluminium window frame



Wooden window frame

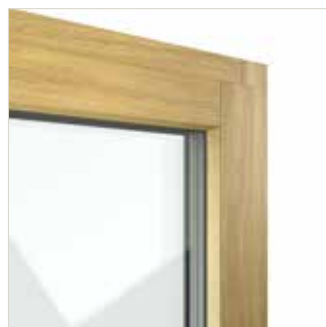

Inlay window frame



Building connection options

The position of the window in the reveal can also be freely selected.

More information can be found under [Centre → Building connection → Mounting method → Models for the whole of Europe](#)

FIN-Project Nova-line Twin Cristal aluminium-wood window, single-sash model, colour 3X05 Oak Carbon Grey, enamel colour G01 Jet Black, handle series 11 E03 Black anodised, window frame flush on interior, fixed flush on interior to mounting frame.



Frame shape

→ Sash frame outline on interior

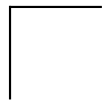

Reduced look

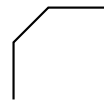

Bevelled look

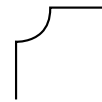

Traditional look

uPVC window frame



Aluminium window frame



Wooden window frame



Inlay window frame



→ Mullion on interior

Mullion

Narrow mullion (up to 3.2 m² bay area)

Without cover strip



With cover strip

only where interior material is uPVC for Classic-line, Slim-line and Step-line sash models



History with central handle

only where interior material is uPVC for Classic-line, Slim-line and Step-line sash models



Frame shape → Cristal sash

Single or double-sash. Also with integral solar protection.

With the Cristal model, the sash frame completely disappears behind glass on the interior side of the window. With double-sash windows too, this produces a full-area glass front on the interior. With the Twin coupled sash, an interstitial shading device is included.

Single-sash

Double-sash

With traditional sash



With coupled sash

With integral privacy and solar protection. More information can be found under [Exterior → Protection → Sun/Heat → Shading in sash](#)



Edge enamel colours.

More information on the enamel colours can be found under [Exterior → Design → Colour/Finish → Enamelled glass](#)

FIN-Window Slim-line Cristal uPVC-uPVC casement door and window, double-sash model, colour 01 White extra smooth, enamel colour G03 Khaki Grey, handle series 12 colour 43 Stainless Steel.



Frame shape → Cristal sash

Window frame
offset from sash frame

Window frame
flush with sash frame

uPVC window frame
with traditional or
coupled sash
(shown here)



Aluminium window frame
with traditional or
coupled sash
(shown here)



Wooden window frame
with traditional or
coupled sash
(shown here)



Inlay window frame
with traditional or
coupled sash
(shown here)



FIN-Project Step-line Cristal aluminium-aluminium window, single-sash model, colour F905 Jet Black fine texture full-strength, enamel colour G01 Jet Black, handle series 2 M03 Black matt. Windows with concealed hinges offer fewer surfaces for dust and dirt to accumulate and are accordingly easier to clean.



Frame shape → Cristal sliding sash

Glassy elegance that slides open.

Completely covering the inner face of the frame by glass gives the sliding door a particularly slimline appearance while adding a stylish note to the interior.

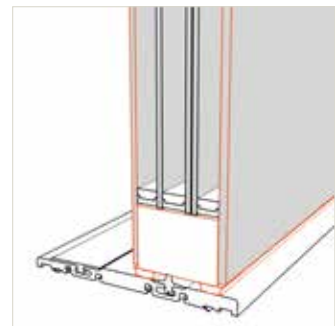

Nova Plus Cristal

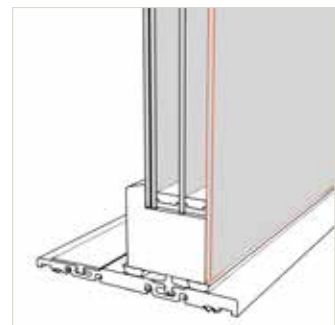

Cristal

In the Nova-line Plus Cristal version, the lift-and-slide door sash catches the eye on either side with its attractive all-glass look.

FIN-Slide Nova-line Plus Cristal aluminium-wood lift-and-slide door, colour 3X03 Oak Sand Grey, enamel colour G01 Jet Black, handle series 15 E03 Black anodised.



Handles/Hinges → Windows and sliding units

Handles add an aesthetic note.

Classic or modern, traditional or distinctive – Finstral offers you a wide variety of shapes, materials and colours for your handles. All options are available for both windows and sliding units so as to ensure the consistency of your handle design, regardless of opening action. Our windows can, of course, also be ordered without handles.

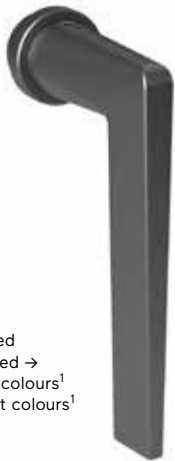

Aluminium
Clear anodised
Black anodised →
Full-strength colours¹
Special effect colours¹

Oval rose →
Round rose →

Series 11



Aluminium
Clear anodised →
Black anodised
Full-strength colours¹
Special effect colours¹

Stainless steel

Oval rose →
Round rose

Series 12



Aluminium
Clear anodised →
Black anodised
Full-strength colours¹
Special effect colours¹

Stainless steel

Oval rose →
Round rose

Series 13



Aluminium
Clear anodised
Black anodised →
Full-strength colours¹
Special effect colours¹

Oval rose
Round rose →

Series 14



Aluminium
Clear anodised →
Black anodised
Full-strength colours¹
Special effect colours¹

Stainless steel

Oval rose
Round rose →

Series 15



Aluminium
Clear anodised
Black anodised →
Full-strength colours¹
Special effect colours¹

Stainless steel

Oval rose
Round rose →

Series 16

¹Wood decor colours are not possible.

Choose the handle you desire, with a classic oval or minimalist round rose, from a range of 200 colours. Pictured on the left is Series 12 with an oval rose in LC32 Pale Bronze and, on the right, Series 12 with a round rose in 894 Sablé (frame colour).



Oval rose



Round rose



Aluminium
White
Pearl White
Clear anodised →
Aluminium coloured
Bronze coloured

Brass
Glossy

Oval rose →

Series 1



Aluminium
White matt
Black matt
Aluminium coloured →

Square rose →

Series 2



Stainless steel →

Oval rose →

Series 3

Handles/Hinges → Casement doors

Your second means of entry.

Our handles for side-hung casement doors always take the form of lever handle sets that are lockable on both sides. Your patio door thus doubles up as a side entrance. Finstral lever handles always allow you to ensure the uniformity of your handle design, regardless of opening action. Our casement doors can, of course, also be ordered without handles.

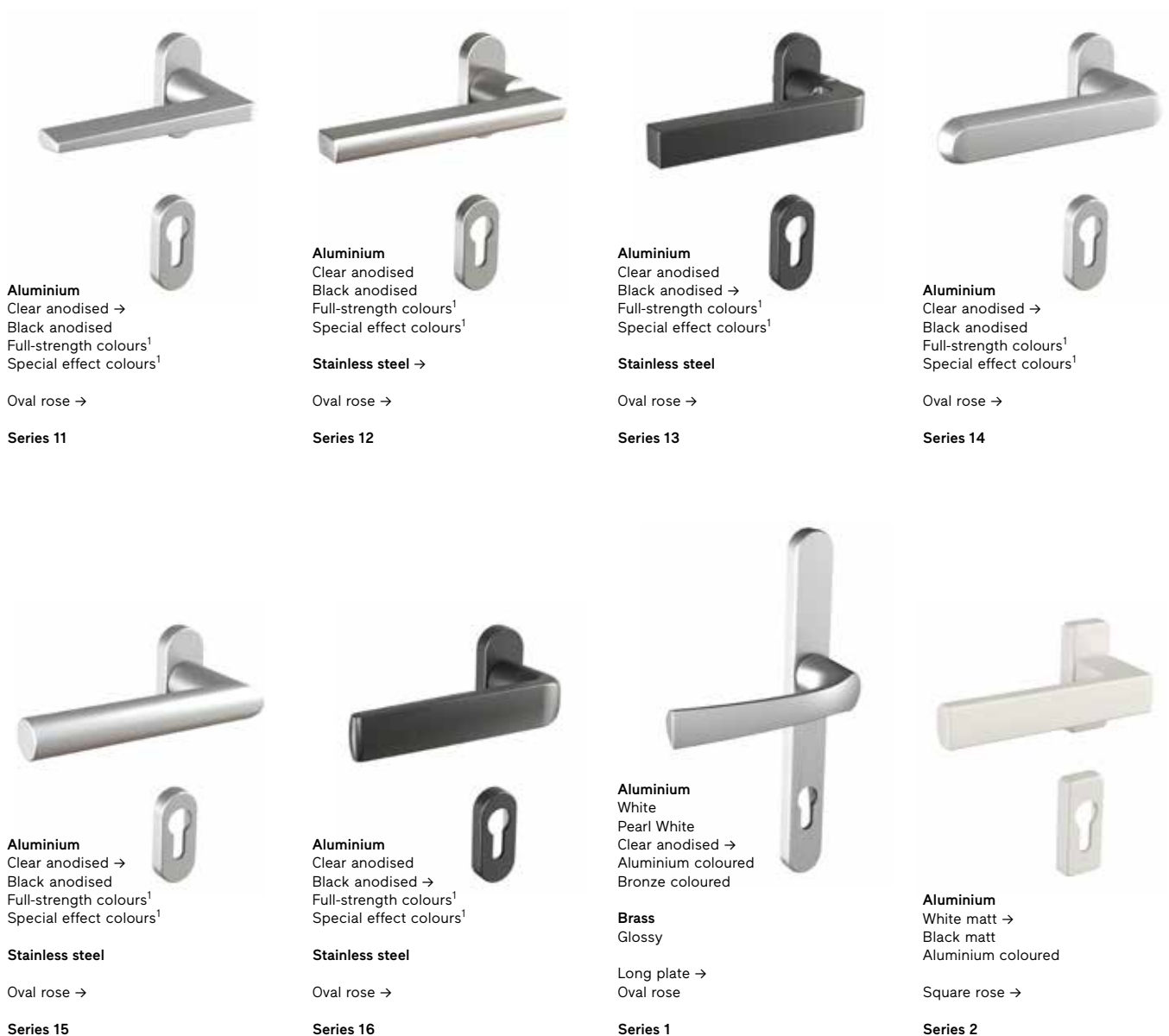

¹Wood decor colours are not possible.

Pull handle and handle strip for exterior.

Casement doors with the Nova-line frame-covering all-glass look are fitted with a black handle strip. For Nova-line Plus casement doors with glass enamelled on the rear face, the handle strip colour matches that of the enamelled glass.



Pull handle in 5 colours

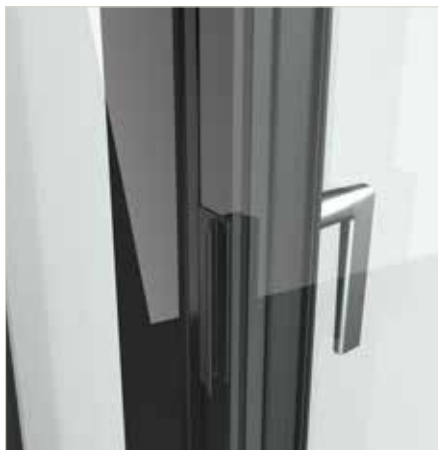

Black pull handle for Nova mullion



Handle strip matching enamel colour for Nova-line Plus sash. With the Nova-line sash, the handle strip is always black.

**Flat handle on exterior.**

If your balcony or patio door is combined with a roller shutter, you can choose a flat version of the outside handle. This ensures that the handle does not obstruct the roller shutter curtain when lowered.

Handles/Hinges

→ Lift-and-slide doors

Always a match for the window handle.

Our lift-and-slide door handles are perfectly coordinated with the window handles in terms of shape, material and colour. So our range of handles always allows you to ensure design consistency, regardless of opening action. Our sliding doors can, of course, also be ordered without handles.



¹Wood decor colours are not possible.

The lift-and-slide door handles from Series 11 to Series 16 are available in all aluminium colours. Pictured here is Series 12 in Aluminium Black anodised.



Flush pull and handle strip for exterior.

On the exterior, you can optionally fit your sliding door with a flush pull in the frame colour.

Lift-and-slide doors with a Nova-line Plus glass-covered frame on the exterior are available with a convenient handle strip on the outside.



Flush pull
in frame colour



Flush pull
in clear anodised aluminium



Handle strip
for Nova-line

Handles/Hinges

→ Exposed/concealed hinges

Standard or elegant.

You have the choice of fitting our windows with either visible hinges that match the frame colour as closely as possible or concealed hinges for a more elegant look.

Concealed.

Windows with concealed hinges offer fewer surfaces for dust and dirt to accumulate and are accordingly easier to clean. Window sashes with concealed hinges have a maximum opening angle of 93°.

Visible.

Window sashes with visible hinges have a maximum opening angle of almost 180°. The caps of the visible hinges are available in several colours so as to provide the best possible match to the window sash frame colour.



Stark visual contrast or tone-on-tone.

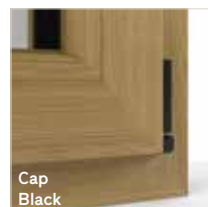
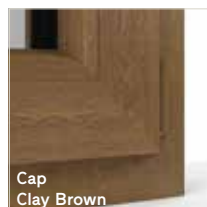

Accessories

→ Interior windowsill

Inch-perfect fit, in matching colour.

Would you like to add an interior windowsill? On request, we can manufacture them from laminate-faced MDF panel or wood to fit your window perfectly.



Interior wooden windowsill



straight
side edge



rounded
side edge

Interior windowsill made of laminate-faced MDF board



straight
side edge



rounded
side edge

Accessories

→ Roller shutter box covering

Aesthetically convincing refurbishment.

Existing roller shutter boxes are easy to retrofit with insulation in the course of window replacements. Finstral also provides for the aesthetically convincing modernisation of the interior coverings. For your roller shutter box or inspection cover facings, you can choose from a wide range of options in uPVC, aluminium or wood in all available colours.

uPVC

Aluminium

Wood

Roller shutter box



Inspection cover



From old (left) to new (right): FIN-Project Slim-line aluminium-wood window, double-sash model, colour 2X01 Oak Nature, slide-on shutter box covering with real-wood veneer in frame colour, with wooden windowsill in frame colour and handle series 2, colour 79 Aluminium coloured.



Interior → Operation

For safe, intuitive use.



Opening actions
User comfort
Safety in use
Ventilation



Opening actions

→ Tilt-and-turn window

Always smoothly operating and weathertight.

At Finstral, the tilt-and-turn window is standard. The perimeter locking mechanism ensures a permanently high tightness while the tilt function provides for efficient ventilation. The window is operated by handle, but may optionally be motorised. The handle height may be custom-adapted based on the modular grid. More information on Finstral tilt-and-turn window user comfort can be found under [Interior → Operation → User comfort](#)

Bottom-hung fanlight.

Fanlights always vouch for optimum ventilation. This is because upward-rising warm air can readily escape through the fanlight opening. Fanlights are always easy to operate by lever, crank or motor (including concealed model). Optionally available with concealed hinges.



Handle



Hand lever



Crank



Motor (also concealed)

FIN-Project Slim-line aluminium-wood window, double-sash model, colour 2X01 Oak Nature, with wooden windowsill in frame colour and handle series 11 E03 Black anodised.



Opening actions

→ Casement door

Lightweight and secure, indoors and outdoors.

Casement doors provide access to balconies and patios while admitting plentiful light into the interior. They are available in a wide range of colours and with numerous handle models.

More information can be found under [Interior → Design → Handles/Hinges → Casement door](#)

Operation.

Finstral offers both tilt-and-turn and side-hung casement doors. They can be optionally fitted with handle sets – including security lock cylinders – that are lockable on either side, offering an ideal solution if you want to use the patio entrance as a fully-fledged side door.

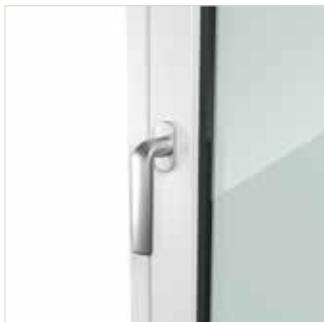

Tilt-and-turn door with window handle



Lockable tilt-and-turn door with window handle



Side-hung door, lockable on either side



Side-hung door, lockable on either side

Thresholds.

The casement door threshold is formed by the frame, which, for uPVC doors, is fitted as standard with tread protection. For even greater convenience, a version with a flat (only 2 cm projection), barrier-free, wheelchair-accessible threshold is also available.



Exterior uPVC with step protection



Exterior aluminium



Flat (2 cm)

FIN-Window Slim-line uPVC-uPVC fixed light and casement door, single-sash model, colour 45 White satin finish, handle series 11 56 Aluminium anodised.



Opening actions

→ Lift-and-slide door

Always barrier-free and generously sized.

The FIN-Slide movable sash lifts slightly when it is opened and drops back onto the threshold when closed: this mechanism allows doors to be designed with very flat thresholds and a very high degree of tightness. The design also allows for extra-large sashes that can be effortlessly opened and closed – and are available in a wide variety of materials and models.

More information on how your lift-and-slide door can be used to provide secure ventilation can be found under [Interior → Operation → Ventilation → Hardware options](#)



Operation.

The sash of the lift-and-slide door is fitted with high-grade rollers for easy movement. With the soft-stop option, the sash brakes mechanically before reaching the end position. In addition to manual operation, it is possible to fit the door with an electric motor that can also be integrated in Smart Home systems.



Threshold.

The threshold of Finstral lift-and-slide doors is flat (only 2 cm projection) and offers barrier-free, wheelchair access. The absence of any recesses where dirt can accumulate also makes it easy to clean. The metallic-film-finished uPVC has a stylish look while vouching for optimum tightness.

More information can be found under [Centre → Insulation → Tightness](#)

FIN-Slide Slim-line aluminium-wood lift-and-slide door, colour 1X06 Spruce Beige Grey, handle series 15 43 Stainless Steel.



Opening actions

→ Lift-and-slide door

Symmetric or asymmetric look.

If you prefer aesthetic symmetry, we can adapt the frame widths of the fixed sidelights to that of the sliding sash. The asymmetric version of the FIN-Slide door, on the other hand, offers different frame widths and a maximum glass area.



Symmetric: same frame widths for fixed light and sliding sash



Asymmetric: different frame widths, maximum glass area

FIN-Slide Step-line uPVC-uPVC lift-and-slide door, colour 45 White satin finish, handle series 11 56 Aluminium clear anodised. As an added option, the movable sliding sash can retract into the wall – which is ideal for rooms with small wall areas as this frees up space for furniture.



Opening actions

→ Lift-and-slide door

With or without mullion.

Where large lift-and-slide door systems incorporate two meeting movable sashes, the frame can be designed with or without a mullion. The latter is the ideal solution for creating large openings of up to 5 m.



With mullion



Without mullion



FIN-Slide Slim-line aluminium inlay lift-and-slide door, inlay colour C09 Lava Corten Ceramic, support colour Mars 2525 special effect colour aluminium, handle series 15 E03 Black anodised. The high-grade material and colour variants of the inlay design option transform our lift-and-slide doors into a defining element of the interior design.



Opening actions

→ Lift-and-slide door

Glass options.

Are you looking for maximum glass and minimum frame? The fittings and installation options for our lift-and-slide doors offer you ample scope to achieve a minimalist look.

Sash frame.

The sash frame of the lift-and-slide door can be optionally produced with frame-covering glass on the interior and/or exterior. More information can be found under [Interior → Design → Frame shape → Cristal](#)

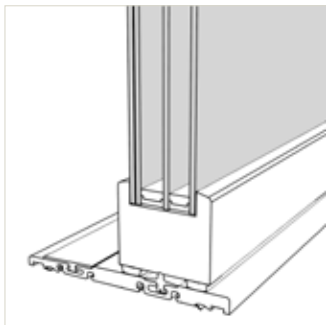

Classic

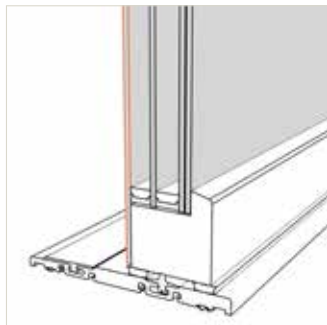

Nova

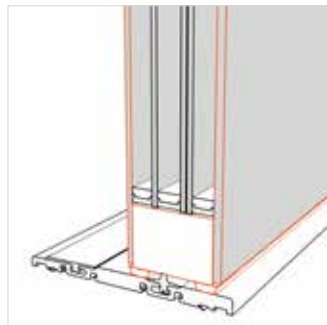

Nova Plus Cristal

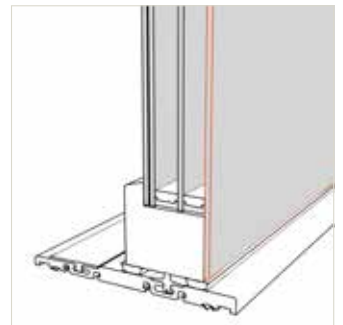

Cristal

Mullion.

The mullion of the lift-and-slide door can be optionally specified with frame-covering glass on the interior and/or exterior. This serves to minimise the visibility of the frame: see page 50.

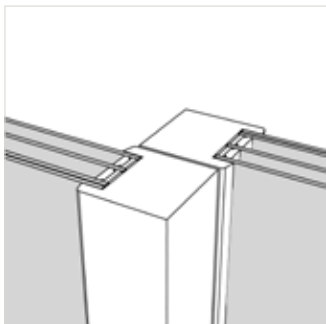

Classic

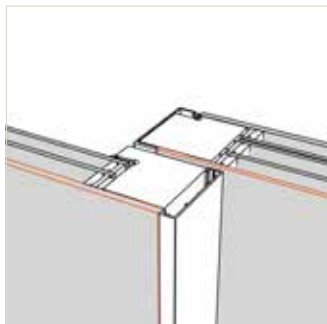

Nova

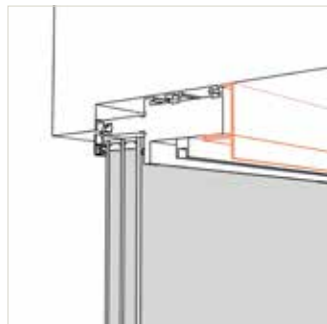

Visible frame

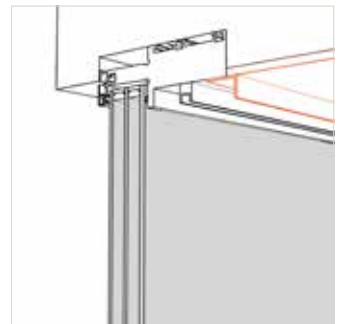

Concealed frame

Installation.

When the lift-and-slide door is installed, the upper part of the frame remains visible. To achieve a frameless look, the frame can be optionally concealed inside the ceiling.

FIN-Vista Frameless window wall with FIN-Slide Nova-line Plus Cristal aluminium-aluminium lift-and-slide door, colour F45 White satin finish fine texture, enamel colour G01 Jet Black, handle series 15 painted in frame colour.



Aesthetically minimalist, functionally flawless. Finstral window consultant Lorraine Elsman knows what construction clients are looking for when selecting lift-and-slide doors and explains why the FIN-Slide line is now even more slender, stylish and intelligent.



Window consultant Lorraine Elsman from the Dutch city of Apeldoorn knows exactly what her customers want. Whether windows or sliding doors – everything has to be combinable with everything else while at the same time harmonising with the building's architecture.

“FIN-Slide stands for the ultimate reduced look.”

The trend towards ever larger glass surfaces continues unabated. Is that also the case with lift-and-slide doors?

It certainly is. The increase in the popularity of lift-and-slide doors with slimline frames remains unbroken. In particular, the demand for high-grade FIN-Slide versions with frame-covering glass, wood on the interior and high-quality handles is growing at an above-average rate. That is why we are particularly delighted that our newly updated range of lift-and-slide doors offers even more options in this regard.

What exactly are these novelties?

With FIN-Slide, we are offering a virtually fully glazed lift-and-slide door model. It is now available in even bigger sizes of up to 5.96 m width and 2.80 m height. Moreover, the frame widths of the Slim-line version have been reduced by the

full width of a thumb, from 8.4 to 6 cm. The frame can be concealed on both the interior and exterior. And, with the Nova-line model, the additional use of stepped glass means that visible frame widths barely exceeding 2 cm are also achievable. For ample daylight and the ultimate reduced look.

Are there any other benefits apart from convincing aesthetics?

In the version with frame-covering stepped glass, the frame of the fixed light is concealed on the exterior. Quite apart from the elegant appearance, this also simplifies care as the frame now has no edge where leaves, dirt or road salt can collect.

Finstral is synonymous with variety and maximum design freedom. Are you also setting new benchmarks in the design options for lift-and-slide doors?

This was among the key criteria for our reworking of the FIN-Slide range. As the frame material, Finstral offers uPVC or aluminium for the exterior and, in addition to these, wood or the Cristal version with frame-covering glass for the interior. And this in any of the 250-plus colours and finishes: from the subtly shimmering aluminium special effect colour Sablé or the through-coloured uPVC in silk grey with satin finish to oiled oak. Moreover, the innovative “inlay” option opens up virtually endless possibilities in the choice of materials for designing the interior finishes. Ceramic, precious wood or metal: in all, there is a choice of 22 finishes for inlaying in the support profile. As for the handle, customers can select one of eight high-grade design series while a flush pull, also available in the frame colour, can add an elegant note on the exterior.

Does FIN-Slide also score in terms of thermal insulation, protection and ventilation?

With a thermal transmittance of up to U_w 0.82 W/m²K, the lift-and-slide door earns top marks in terms of insulation – a distinction of which we are very proud. And, as always with large glass surfaces, Finstral recommends the use of solar

protection glazing for FIN-Slide. Contemporary Sun Control glass achieves an approx. 40 % reduction in heat gain compared to normal double glazing while light transmittance is only 10 % lower. This allows the interior to be flooded with light without heating up too quickly. Nor have we forgotten the option of providing secure trickle ventilation or an additional ventilation sash.

What about operation? Lift-and-slide doors can weigh up to several hundred kilos ...

That’s true. Nonetheless, using FIN-Slide is child’s play. High-grade rollers ensure the smooth movement of the sash. It lifts slightly when it is opened and drops back onto the threshold when closed: this mechanism allows doors to be designed with very flat thresholds and a very high degree of tightness. FIN-Slide thus provides for traditional, manual operation. The soft-stop function is available as an added option for extra convenience. This brings the lift-and-slide door to a gentle halt just before the end position. Maximum user comfort is offered by the motorised version, which opens and closes fully automatically at the press of a button.

Finstral Studios give prospective buyers a first-hand experience of the diverse functions and impressive look of the sliding door range.



Opening actions

→ Parallel sliding-tilting door

Always weathertight and space-efficient.

With parallel sliding doors, the movable sash, when opened, runs parallel to the fixed light on the inside. This makes it particularly suitable for medium-sized sliding door solutions where a higher threshold is possible. Roller mushroom head bolts ensure an extremely tight contact between parallel sliding door and frame, thereby achieving top performance in terms of airtightness and driving rain tightness. Our parallel sliding doors are available in all frame shapes and materials – with the exception of Cristal, Twin, Inlay and flush-fitting interior models.



Tilt function.

Your sliding door can be optionally provided with a convenient tilt function.

Threshold form.



Frame, fitted as standard with step protection for uPVC



5 mm high threshold

Sliding carriage version.



Sliding carriage cover, available in White and Silver

FIN-Project Nova-line aluminium-aluminium parallel sliding-tilting door with fixed sidelight, colour M01 White matt full-strength, handle series 13 colour 56 clear anodised.



Opening actions

→ Sliding door

Always simple. Always attractive.

With FIN-Scroll the movable sash, when opened, simply slides over the door's fixed light. This is our aesthetically appealing, lightweight and economical alternative to the traditional lift-and-slide door. Always ideal when maximum insulation performance and tightness are not the prime consideration.

Frame design.

With an asymmetric frame design, the fixed light and sliding sash have different frame widths so as to maximise the glass area. With the symmetric version, the two sliding sashes have the same frame width.



asymmetric



symmetric

Fixed sash visible or built into wall.

A concealed version of the sliding door is also available. Here, the sidepanel is simply pushed into the wall. The ideal solution for rooms with small wall areas as this frees up space for furniture.



Sash disappears into wall

Threshold.

The only 3 cm high threshold ensures trip-free movement through the opening.

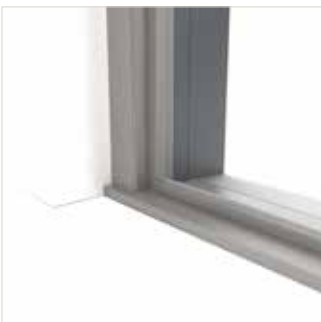

Flat threshold

Two opposite-sliding sashes.

On request, our FIN-Scroll sliding door is also available with two opposite-sliding sashes without a mullion.



Without mullion

FIN-Scroll Slim-line aluminium-uPVC sliding door, colour 01 White extra smooth, handle series 12 colour 43 Stainless Steel with round rose.



Opening actions → Folding door

Always maximum opening.

FIN-fold combines the advantages of an inward-opening casement door and a sliding door.

Our folding door is particularly suitable for large openings with no fixed sidepanels. It is also easy to use – and barrier-free to boot. The flat door thresholds always ensure level, trip-free movement through the opening.

Fully folding.

Folding doors can be fully opened by sliding the sash stack completely to the side and swinging it inwards.



Barrier-free.

With a height of only 2 cm, the thresholds of our folding doors create a barrier-free junction between indoors and outdoors. The standard uPVC threshold profile also ensures optimum insulation. Alternatively, the threshold variant with frame may also be selected.



Flat threshold only 2 mm high



Threshold with frame

Folding configurations.

The unique design of FIN-Fold allows the creation of extra-large openings up to around 4.5 m in width, depending on the weight of the glass.



up to approx. 2.0 m wide*



up to approx. 3.7 m wide



up to approx. 2.2 m wide

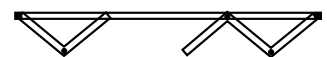

up to approx. 3.7 m wide



up to approx. 4.0 m wide*



up to approx. 4.5 m wide

* particularly user-friendly design, as all sashes run in track

FIN-Fold Nova-line aluminium-aluminium folding door with four symmetrically configured sashes, colour F716 Anthracite Grey fine texture full-strength, handle series 276 Aluminium coloured.



Opening actions

→ Sliding window

Always comfortable and easy to operate.

All Finstral sliding systems are also available as windows. Not only are our sliding windows easy to operate, their narrow frames also ensure that ample daylight is admitted into the interior. Sliding windows are particularly suitable for rooms, e.g. kitchens, where (working) space is in short supply.

Four sliding window models.

We offer sliding windows in four versions: the FIN-Slide lift-and-slide window guarantees outstanding tightness values and impresses with its elegant design. It is easily manageable and simple to operate. Our FIN-Scroll and FIN-ScrollLight sliding windows offer a good compromise between ease of

use and tightness, where achieving maximum performance values is not the prime consideration. Roller mushroom head bolts ensure an extremely tight contact between parallel sliding/tilting window and frame, thereby achieving top air-tightness and driving rain tightness values.

	FIN-Slide	FIN-Scroll	FIN-ScrollLight	Parallel sliding/tilting
				
Aesthetic appeal	+++	++	+	exterior +++ / interior +
Tightness	++	+	+	+++
User comfort	+++	++	++	+
Sash size	+++	+	+	++
Security	++	+	+	+++

FIN-Slide Slim-line Cristal aluminium-aluminium sliding window, colour Mars 2525 special effect colour, handle series 14 E03 Black anodised with round rose.



User comfort → Standards

Always easy to use.

A perfect window should always be easy to operate. Hence our refusal to make any compromises on functionality and guarantee high user comfort even with our standard window fittings.

Always bonded, not just fixed with glazing blocks.

At Finstral, glass and profile are bonded together to form a stable unit. This makes the window sash stiffer and easier to operate.



Always lifted, never hooked: sash lifter.

Fitted as standard for sash heights upwards of 841 mm, the sash lifter serves to lift the sash into the optimum closing position during every closing operation. This prevents it from dragging or snagging even after years of service.



Always safe, never wobbly: anti-mishandling device.

Finstral handles are fitted with anti-mishandling devices as standard. These prevent the handle from being turned when the window is in the tilted and open position, which would cause it to become unhinged.



Always rolling, never scraping: roller mushroom head bolts.

The self-adjusting roller mushroom head bolts roll smoothly into the locking part. This makes for smooth operation – and weathertight closing – of the window.



→ Options

For even greater comfort.

Lock monitoring by sensor, automatic opening at the press of a button or closing assistance for windows in the tilted position – all these options are available for maximum ease of operation.

Window sensor.

The sensor automatically monitors the opening status of the window and reports it to your central heating, air-conditioning or alarm system. This both enhances security and saves on heating costs because your heating system self-regulates when the window is open. With the window sensor, Finstral windows can be integrated in all standard house control systems and are Smart Home-compatible.



Motorised opening.

Motorisation allows effortless opening of even poorly accessible fanlights and large lift-and-slide doors. Regardless of the means of operation – whether by wall switch, remote control or smartphone – the motorised opening function can be integrated in standard house control systems and is Smart Home-compatible.



Tilt closing assistance.

Smooth tilting: the closing assistance function uses a spring mechanism to facilitate closing of the window from the tilted position. It is ideal for particularly heavy sashes, e.g. all-glass models.



Casement doors have to meet numerous demands. Their manufacture and installation are surprisingly complex. The threshold area, in particular, has to fulfil multiple functions. Gustav Burger is Head of the Technical Service team for window walls and sliding doors. Here he talks about barrier-free design and the paradigm shift between wheelchair-accessible and zero thresholds.

“For thresholds, barrier-free access is just one of many requirements.”

“Barrier-free design” in relation to casement doors is a bone of contention among professionals. Why?

Because the exact meaning of barrier-free design and its relative significance compared to the other requirements placed on thresholds are not quite clear. While the debate in Germany centres on good wheelchair access, attention in Italy is focused on watertightness given the growing incidence of heavy rainfall. The relevant law passed in 1989 stipulates a maximum threshold height of 2.5 cm to eliminate architectural barriers. There are no discussions about any further lowering: indeed, customers would rather have higher thresholds to provide better protection against water. German standard DIN 18040 states that “lower door stops and thresholds” are only permitted – and then with a maximum height of 2 cm – if they are “technically indispensable”. This opens up a wide debate in relation to everyday practice. Or, in the words of Professor Jörn Lass, Head of the Institut für Fenstertechnik (ift) Rosenheim: “It is a topical subject brimming with contradictions in standards, regulations, project specifications and technology.”



Burger knows all about windows. He has been working at Finstral for 30 years and is now Head of the Technical Service team for window walls and sliding doors. His motto: what always matters is the long-term functionality of a casement door.

Apart from barrier-free access, casement door thresholds must also meet other functional requirements for good tightness and insulation.

Where does Finstral stand in this debate?

We share Professor Lass's view that casement doors, as the interface between interior and exterior, are subject to far more requirements than simply barrier-free access. And, as developers, we endeavour to reconcile these as best we can. Moreover, this is doubtless the reason why the subject is causing the standards committees such headaches. Holistically conceived, clear-cut regulations would, of course, benefit everyone.

So what requirements do casement doors have to meet?

With casement doors, the bottom profile of the sash frame has to withstand the greatest loads: on the one hand, it is subject to thermal loads due to its exposure to sunshine – both directly and indirectly due to reflection from the ground in front of it. Then there are mechanical loads resulting from the size and weight of the glass panes in casement doors that bear on the lower frame. To prevent the frame from warping under the decades-long weight loads, it is stabilised in the closed position by at least two security locking parts in the threshold. This prevents upward, downward, outward and inward movement, thereby eliminating the risk of deformation while also ensuring uniform contact pressure of the weatherstrips. This all sounds technical, but is crucial because only dimensionally stable profiles can provide a decades-long guarantee for the key door functions, such as airtightness, driving rain tightness, thermal and sound insulation, or insect resistance. At the same time, the bottom locking parts significantly improve burglar resistance. Without a threshold, no provision can be made for these stabilisation points and a weatherstrip. Although we are only talking about two centimetres – which can also be designed for easy wheelchair access – these are nonetheless essential for meeting all the various design requirements.

So would you recommend a low threshold instead of a zero threshold?

In the vast majority of cases, yes. For persons with disabilities, barrier-free design is an important feature – without any doubt. However, on the one hand, that doesn't always necessarily mean a zero threshold: very often, good wheelchair access should also suffice. On the other hand, the zero threshold solutions available on the market quite simply have many disadvantages.

What are the specific disadvantages of zero thresholds?

Given that the threshold is not raised, water is able to enter it. This necessitates downward drainage via an elaborate channel system, regardless of whether the threshold is in a weather-sheltered area or not. Which requires considerable effort and can only provide a solution in the case of new-build or refurbishment projects. It is unsuitable for window replacements. And zero thresholds have no locking points



along their length. They are generally fitted with magnetic seals which, given the lack of contact pressure, can never provide the same degree of tightness as a weatherstrip.

How do your customers feel about the zero threshold?

We receive virtually no enquiries about it. This is no doubt due, among other things, to the considerable extra cost of such a solution if it is to be implemented properly. But the growing number of heavy rainfall events also deter customers from choosing zero thresholds.

What needs to be considered in the design of flat thresholds?

Under the RAL Guideline, flat thresholds should be limited to weather-sheltered areas and/or those provided with a drainage channel. The indoor floor covering should also be moisture-resistant. These basic rules have always been standard for doors. They should also be applied to casement doors with flat thresholds. Large roof terraces with open balustrades are particularly vulnerable to the action of water blown from the floor against the door units by the wind. This demands the specification of more stringent tightness requirements for the threshold constructions – all the more so given the more frequent heavy rainfall events and heatwaves caused by climate change.

Earlier on you mentioned tilt-and-turn casement doors. Do lift-and-slide doors actually need locking points along the threshold?

Not as we see it. The sash weight of lift-and-slide doors is high enough to guarantee sufficient contact pressure for the gasket. And the roller carriage guide rail provides the sash frame profile with horizontal stability. Weight and guide rail also provide optimum protection against burglary. That is why our lift-and-slide door thresholds are designed with even lower thresholds for even easier wheelchair access. Gustav

Safety in use → Hardware

Safe operation for safe living.

Finstral incorporates numerous fittings and functions into its windows and casement doors to facilitate smooth handling and to protect against injury.

Lockable handles.

Push-down handles with or without a visible push-button and lockable handles are fitted as standard to lock the closing mechanism. This prevents both burglars from moving the hardware bolts and unsupervised small children from opening the window on the inside.



Tilt-before-turn function.

With the tilt-before-turn function, the window can always be tilted, but can only be fully opened with the key. Ideal for safe, worry-free ventilation in children's bedrooms or schools.



Turn lock.

Windows with a built-in turn lock can only be tilted but not fully opened. For safe ventilation in schools or other public buildings.



Sash retention device.

The sash retention device prevents the tilt-and-turn sash from dropping out when subject to an extraordinary force, e.g. a violent impact of the sash against the reveal. This is an important safety feature for public buildings with changing users.



→ Safety glazing

Multifunctional protection.

Not everything in life goes according to plan. That is why we offer safety glazing which, depending on the selected version, offers protection against injury, burglary, sound and UV radiation.



Bodysafe – our toughened safety glass.

Our Bodysafe toughened safety glass is highly impact-resistant. If it does break, it will shatter into small, blunt pieces instead of sharp shards. It thus offers good protection against injury to class 1(C)3. Moreover, unlike normal glass that may suffer thermal breakage when shadows are cast across it, our toughened glass is immune to high temperature differences in the glass.

Multiprotect – our laminated safety glass.

Our Multiprotect laminated safety glass comprises two glass panes bonded together with a highly tear-resistant film. In the event of a glass breakage, the film holds the shards in place. This minimises the risk of injury (protection against injury to class 2(B)2). Multiprotect glass can also withstand attempted break-ins with a hammer as the glass will splinter, but cannot be penetrated. Multiprotect is available in the four resistance classes: P1A, P2A, P4A and P5A.



Ventilation

Everyone needs good indoor air quality.

Modern-day windows provide for very good insulation of the interior. This is positive for the building's energy profile, though prevents natural air exchange – making regular ventilation all the more important. This is the only way of regulating humidity, preventing mould growth and providing for healthy indoor air.

90%

of people's time in Europe is spent indoors. Indoor air thus accounts for the lion's share of the over 10,000 litres of air they breathe every day. What many people fail to realise is that indoor air can be up to five times more polluted than outdoor air.¹

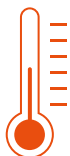

When is an indoor environment comfortable?

Whether or not we feel comfortable in a room essentially depends on the indoor air temperature, surface temperature and humidity. Most people find a habitable room temperature of 20 degrees Celsius comfortable while humidity should lie between 40 % and 60 %. If it falls below 30 %, the dry air can irritate the mucous membranes. If it permanently exceeds 50 %, then the risk of mould growth increases. A simple hygrometer can be used to measure humidity.



A watering can every day.

An average four-person household releases 6-12 litres of water per day into the air. Whether by cooking, washing, drying laundry, showering or simply breathing: we release moisture around the clock. And it is not just the building occupants. Houseplants also increase interior humidity. Which is why proper ventilation in summer and winter is so crucial.²



Health at risk.

Mould has been shown to be a health risk. Allergic reactions, skin irritation, respiratory diseases, sleep disorders and other complaints are just some of the potential consequences.

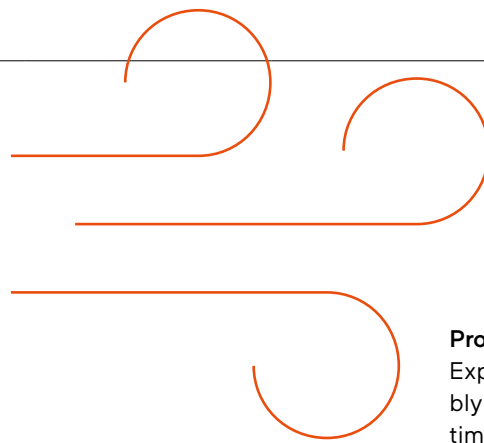

Proper ventilation – this is how to do it.

Experts recommend “shock” or preferably cross ventilating the interior several times a day.

For how long depends on the time of year. In winter, five to ten minutes with the heating turned off suffices. Steam and moisture can thus escape with little heat loss, and walls and furniture do not cool down. Ventilating for 20 to 30 minutes is ideal in summer, preferably in the morning and evening when the outdoor temperatures are lower. So-called “moisture peaks” in bathrooms and kitchens should be eliminated immediately by means of intensive window ventilation.³



Residual moisture in new-builds.

New-builds require so-called “shock” (intermittent) ventilation three to four times a day for 10 to 15 minutes. This is because fresh construction materials release moisture – so-called residual building moisture.



How does mould form on windows?

Mould is primarily a consequence of water condensation. This, in turn, results from one of the physical properties of air: warm air can store more water than cold air. Large temperature differences between indoors and outdoors cause moisture to condense on cold window surfaces. Joints and rubber gaskets, in particular, are an ideal breeding ground for mould spores.

What types of ventilation are there?



“Shock” (intermittent) ventilation.

Windows are fully opened to bring about a rapid exchange of air.



Cross ventilation.

Opposite windows or doors are opened to create a draught. Note: A strong draught can cause windows and doors to slam shut on their own.



Continuous ventilation.

Only advisable with continuous mechanical ventilators, e.g. for window rebate. Continuous tilt ventilation, on the other hand, provides little air exchange and allows large amounts of heat to escape. It may also cause the window reveal to cool down, thereby promoting the formation of unhealthy mould.

Sources:

¹ WHO European Report 2013, EPA, Aarhus University, CBST, <https://susproc.jrc.ec.europa.eu/product-bureau/sites/default/files/2021-11/4.1.ENV-2020-00029-01-02-DE-TRA-00.pdf>

² verbraucherzentrale.de, <https://www.verbraucherzentrale.de/wissen/energie/heizen-und-warmwasser/heizen-und-lueften-so-gehts-richtig-10426>

³ BMUV (German Federal Ministry for the Environment, Nature Conservation, Nuclear Safety and Consumer Protection)

Ventilation is paramount in safeguarding good indoor air quality. This is because fresh air supplies oxygen for our metabolism, dilutes odours and pollutants, and provides cooling. In an interview, ventilation expert Annamaria Belleri also explains why the concept of a comfortable living climate is highly complex.



Annamaria Belleri is an energy and environmental technology expert. Her research at the Institute for Renewable Energies/ Eurac Research in Bozen focuses on ventilation solutions and strategies for efficient building ventilation using natural ventilation potential. She has headed the “Healthy and Comfortable Buildings” research team since 2022.

“Build tightly – ventilate properly: the maxim for energy efficiency.”

Today’s increasingly weathertight building envelopes are having a significant impact on indoor air quality. Why is ventilation important?

Good ventilation makes a major contribution to the health and comfort of building users. Its primary function is to supply us with oxygen and dilute human metabolic products such as carbon dioxide and odours. It also helps to maintain good indoor air quality by diluting and removing other pollutants emitted in interior spaces. Of course, the priority is always to avoid pollutants indoors.

Ventilation may also offer a means of cooling the interiors of airtight and thermally insulated buildings, which are more prone to overheating. This energy-efficient use of natural or mechanical ventilation to cool indoor spaces is known as “ventilative cooling”.

What is it essential to look out for when ventilating?

“Build tightly – ventilate properly” – that is the maxim for energy efficiency. In other words, air exchange must be properly controlled so as to minimise energy consumption while at the same time ensuring good indoor air quality. Excessive moisture must also be avoided to prevent mould. Various factors need to be taken into account depending on the ventilation system and strategy as well as the building location and neighbourhood: external noise, outdoor air quality and humidity ...

Outdoor air is warm and humid in summer, cold and dry in winter. How does this affect ventilation? This problem can be solved by ventilating when the outdoor conditions are more favourable, e.g. in the early morning in summer and in the afternoon in winter.

A good indoor living climate depends on finding the right balance between indoor temperature and humidity. What ranks as a pleasant indoor climate?

The term “comfort” describes a state of mind. It is achieved when building occupants express their satisfaction with the indoor environment around them. The concept of comfort has also been standardised in construction standards, and building regulations set out strict specifications for temperature and humidity. In the real world, however, the definition of comfortable indoor environmental conditions is more complex and requires the involvement of numerous disciplines – from building physics to psychology. There are several factors related to climate trends, social understanding, cultural differences and economic status that influence the human experience of indoor spaces. In the course of time, people to some extent become addicted to particular indoor conditions. For example, the increasing use of air conditioning systems not only reflects the warming-up of the climate, but also the fact that they have become a status symbol. Another shortcoming in the efforts to standardise comfort stems from the treatment to date of indoor environmental conditions in terms of four separate criteria – visual, thermal, acoustic and IAQ (indoor air quality) – which are evaluated independently of each other even though, in reality, people perceive them as a whole. Other factors such as the views afforded by windows or background noise have not been taken into account.

Recent research into ways of unlocking energy-saving potential examines a range of criteria. It has been found, for example, that people are more likely to tolerate indoor temperatures outside the standard range if windows offer attractive views and links with the outside world.

What is the relationship between subjective perception and a measurably healthy living climate?

The real question is what we mean by a healthy living climate. Physiological studies examine the impact of static indoor environmental conditions on health. According to these, it appears that constant temperature and humidity cause our metabolism to become more sluggish and less able to adapt to varying temperature conditions – which can, in turn, induce a series of potentially related illnesses. This may pose additional risks in the context of a changing climate, where heatwaves are likely to occur more frequently and be more intensive. The most recent research thus tends to focus on dynamic environments as a means of improving health, but also of exploiting the energy-saving potential associated with dynamic indoor conditions.

How can good air quality be achieved even in case of heavy environmental pollution?

Irrespective of whether the pollution sources are outside, various solutions such as filters, air purifiers or controlled ventilation are available to combat the specific pollutant concentration, together with natural ventilation where the concentrations are lower. Unlike natural ventilation systems, mechanical ones usually provide air filtration options. Of course, measures to reduce air pollution must also be taken at a political level, e.g. through building refurbishment, a switch to electromobility and the use of bicycles, the improvement of public transport services along with other sustainable mobility initiatives.



Healthy indoor climate: the regulation of humidity and prevention of mould growth necessitate regular ventilation that is geared to the time of year.

Ventilation

→ Hardware options

Options for purposeful ventilation of interiors.

Windows should always admit two things into living spaces – light and air. Given that modern windows, in particular, are highly weathertight, we offer a wide selection of needs-oriented options appropriate to the ventilation of your interiors that will keep moisture and mould firmly at bay.

Summer/winter tilt position.

Ventilate according to the time of year: the handle can be used to adjust the tilt opening width – up to 17 cm in summer and 4 cm in winter. This ensures that you waste much less heating energy when ventilating during the cold season.



Tilt-and-turn hardware for trickle ventilation in tilted position.

For trickle ventilation, the window handle can be turned between 90° and 135°. The window then opens by 5 mm. Resetting the handle to 180° returns the sash to the normal tilt position.

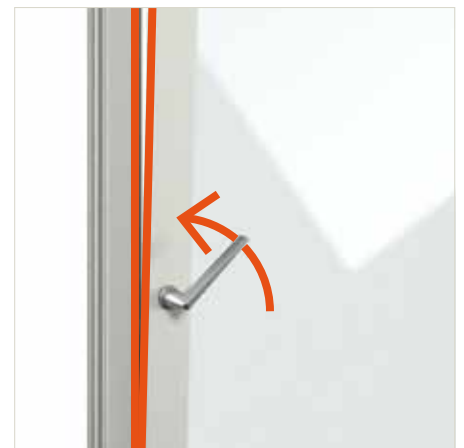

Secure trickle ventilation for lift-and-slide doors.

Ventilation for lift-and-slide doors with no compromises on security: the optional trickle ventilation position allows you to open the sliding sash with a 7 mm gap without completely unlocking it.



Two-step turn opening.

It may not be possible to tilt very tall or unusually shaped windows. Two-step turn opening provides for ventilation via a restricted horizontal turn opening instead of the standard vertical tilt opening.



Sash limiter.

The sash limiter fixes the turn opening of the window sash at 90°. This facilitates "shock" (intermittent) ventilation as the window does not slam shut or hit the reveal even in strong draughts.



Ventilation

→ Vent ventilation sash

Burglar-proof ventilation.

The Vent ventilation sash makes airing your interior particularly unobtrusive. It can be opened or closed as required while remaining concealed by slats and insect screens on the exterior. This makes it impossible to recognise, from the outside, when it is open. Moreover, Vent can be produced in such a narrow size as to rule out any intrusion by burglars.



Aluminium exterior.

The exterior slats of the ventilation sash can be supplied in aluminium in all colours available from Finstral.

More information can be found under [Exterior → Design → Colour/Finish → Aluminium](#)

In uPVC, aluminium or glass-covered on interior.

On the room side, the ventilation sash comprises a uPVC or aluminium infill panel which, on request, can be fully covered by Jet Black enamelled glass.



Always combined with insect protection.

Integrated insect screen: fresh air comes in, but insects stay out.



FIN-Slide Slim-line Cristal lift-and-slide door with aluminium-aluminium Vent, colour M111 Brown Beige matt full-strength, aluminium, enamel colour G03 Khaki Grey, handle series 11 painted in frame colour. Vent is the ideal secured, large-area ventilation solution, particularly for sliding openings without tilt function.



Ventilation

→ Continuous ventilation

Continuous ventilation to combat mould formation.

Take our advice and look for an appropriate ventilation concept in conjunction with your window replacement. In this way, you will make sure that the energy savings achieved by better-insulated windows are not sacrificed through ventilation. Our window ventilators vouch for a healthy indoor living climate through continuous ventilation when the window is closed. This guards against mould formation while at the same time preventing excessive heat loss.

PassiveVent Mini



PassiveVent Midi



Use	For slight continuous ventilation	For good continuous ventilation
Air throughput	For 10 PA ⁽¹⁾ 6 m ³ /h	For 10 PA ⁽¹⁾ 30-32 m ³ /h
Sound insulation	- 1-3 dB ⁽²⁾	Standard 35 dB ⁽²⁾ With humidity control 38 dB With sound insulation module 42 dB
Closure type	Manual closure with cap or always open without cap	Manual locking
Control of air exchange	Air exchange controlled by pressure difference between indoor and outdoor air.	Air exchange controlled by pressure difference and humidity where optional humidity control is integrated.
Colours	White, Pearl White, clear anodised	Exterior cover matching window colour, interior cover White

⁽¹⁾ For a pressure difference of 10 Pa between outdoor and indoor air, this number of cubic metres of air is extracted per hour. Measured independently of profile and hardware, for PassiveVent Mini when installed in pairs.

⁽²⁾ For PassiveVent Mini, we speak of the difference in normalised sound pressure level: based on a window sound insulation of 42 dB, this may be reduced by 1 to 2 dB when using one PassiveVent Mini ventilator and by 3 dB when using two PassiveVent Mini ventilators.

ActiveVent motorised ventilator

For good continuous ventilation

For 8 PA

4 levels up to 45 m³/h

Difference in normalised sound pressure level

$D_{n,e,w} = 53 (-1;-4)$ dB

Motorised locking

Air exchange is electronically controlled.

White, clear anodised

Without ventilation ducts that require cleaning.

Unlike a central ventilation system, local ventilation with ActiveVent does not necessitate installation in the building of ventilation ducts that require regular, elaborate cleaning. You yourself can carry out the annual filter change.

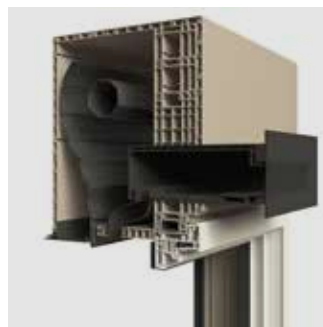
**With heat exchanger on request.**

If you opt for the version with a built-in heat exchanger, this will extract the heat contained in the exhaust air and use this to heat the fresh air intake. This provides you with a permanent supply of fresh air without losing heat and without driving up your heating costs.



Ancillary services
→ Procedure
Smooth processing of
your order.



Coordination
Installation
Acceptance



Coordination

→ Advice on the spot

Expert window counselling at your home.

Our Finstral consultants will visit you on the spot to gain an exact impression of the project. The more familiar they are with the particulars and your personal needs, the more precisely they can tailor their offer. Would you like a home visit? Then please contact us: finstral.com/contact



Rough measurement.

The on-site visit also gives our consultants the chance to take an initial rough measurement of the windows as the basis for reliable pricing.



Clarification of installation procedure.

What is the size of the installation team? What exactly will be done? How long will it take? How will the rooms be protected during the works? Where will the old windows be stored? Our consultant will answer all your installation-related questions and explain the procedure in detail.

Typical questions during home visit:



Burglary protection

Is burglary protection also relevant on the first floor given that it is easy to climb onto the balcony?



Second front door

Will this door serve as a second entrance door and should it therefore be fitted with a double lever handle?



Solar protection

Rooms with large glass surfaces heat up quickly. Would it be advisable to use solar protection glass here?



Sound insulation

Are there noise sources such as busy roads nearby that necessitate improved sound insulation?

Protection from burglars, too much sun or disturbing traffic noise? A home visit will enable our specialist consultants to gain an exact impression of the requirements to be met by your new windows.



Coordination → Advice at the Studio

Experience Finstral products first-hand for a perfect design.

The Finstral Studio is the ideal place for drawing up the design of windows, doors and glass walls. Like kitchen studios or bathroom exhibitions, it enables you to experience the products first-hand, try out many things yourself and familiarise yourself with the wealth of possible configurations. You will be advised by trained experts and receive an answer to every window question.

What to expect at our Finstral Studios.



Bring your own ideas along.

Together we will compose your dream window. You will be surprised at what is possible.

Discover variety.

Wood, aluminium or perhaps uPVC? Ultra-modern or preferably classic? Be inspired by materials, shapes and colours.



Touch, open, close.

First-hand experience is the best way to find out what exactly makes a good window. You can try everything out in our showroom.

Competent answers from experts.

Windows are investments for decades. And they are amazingly complex. Our experienced consultants will help you with your design ideas.

Look out for the “Finstral Partner Studio” label.

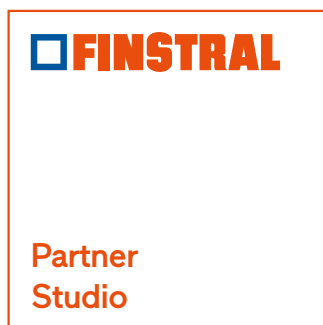

Always featuring an up-to-date product exhibition with experienced consultants: a Finstral Studio is the ideal place for perfecting your design.

There are astonishing differences in window quality. That is why we advise you not to buy any windows until you have first opened and closed them.



Coordination → Design aids

All you need to perfect your design.

From personal counselling and our online Planner to the ordering of material samples: at Finstral, you are provided with everything you need for the customised design of your windows.



References

Look for examples and find inspiration:

- 100-plus references from across Europe
- Documented by photos, short reports, product information
- New-build and refurbishment projects
- Private, commercial and hotel schemes
- Windows, doors, glass walls
- Also available as pdf

finstral.com/references



Information material

Order detailed documents and aids free of charge:

- Window-Check kit
- Installation guidelines for slide-on installation, slide-in installation or two-stage installation with mounting frame
- Brochure on European product standard
- Operating instructions for windows and doors

finstral.com/prospectuses



Samples order

Gain a “real-life” experience of our materials by requesting product samples:

- Materials, colours and finishes
- Frame profiles
- Window corners



Energy-saving measures and possible subsidies

New windows lower your energy demand, thereby cutting costs and unburdening the environment. Here, you can calculate your annual heating cost savings after replacement of your old windows:

finstral.com/samples

finstral.com/energy

Perform the Window-Check!

Always quiet, secure, attractive and weathertight? Checking the condition of your windows is easy enough: it is fast, costs nothing and you can do it yourself. Simply order your Window-Check kit from Finstral and you will find everything you need. If you don't have a kit at hand, then just have a cigarette lighter and a strip of paper ready. And, for the other tests, just follow the illustrations.

Order Window-Check kit: finstral.com/window-check



Included in the Window-Check kit are:



Roller mushroom head bolts for a check on the locking parts



Lighter for checking insulation



Material sample to check for visual defects



Paper strips for checking tightness

Check with lighter.

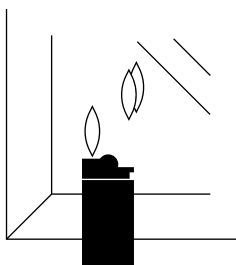

Hold a lighter close to the window pane. Look at an angle from the side at the reflections of the flame in the glass.

Sound insulation: How many flames can you see and how big are the distances between them?



● 2 flames

Single glazing: sound is reduced by only about 25 decibels: every passing car can be clearly heard.



● 4 flames: equal distance between flame pairs

Standard double glazing: sound is reduced by approx. 30-35 decibels. This level of sound insulation is suitable for side streets.



● 4 flames: unequal distance between flame pairs

Sound insulation glazing: sound is reduced by approx. 40-43 decibels: even main road noise is suppressed.

Thermal insulation: How many flames can you see and in what colours?



● 2 flames in one colour

Single glazing: your windows are over 40 years old and are not insulated.

Heat loss is five times greater than for modern windows with thermally insulating double glazing.



● 4 flames in one colour

Double-glazed insulating glass unit: your windows are between 20 and 50 years old.

Heat loss is three times greater than for modern windows with thermally insulating double glazing.



● 4 flames – one of them reddish-violet

Double glazing with thermally insulating coating: your windows are at most 25 years old and offer good thermal insulation. With thermally insulating triple glazing, however, you could save even more energy.



● 6 flames – two of them reddish-violet

Triple glazing with double thermally insulating coating: your windows are less than 20 years old and offer optimum insulation. Heat loss is an impressive 40 percent lower than for thermally insulating double glazing. Your thermal insulation is as good as it gets.



Energy-saving check

Find out how much energy and, thus, money you can save with modern windows. For this, you can use the energy savings calculator on the Finstral website: [finstral.com/energy](https://www.finstral.com/energy)

Check with paper strips.

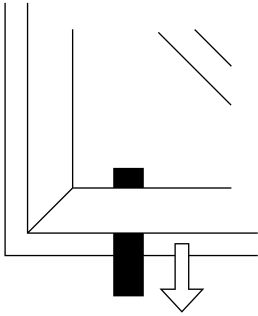

Open the window and clamp the paper strip at a position away from a locking point. Close the window and try to pull out the paper. Try this in several places.

Tightness: How easy is it to pull the paper out of the frame?



- **The paper can be pulled out easily.**

Your windows do not seal properly – this reduces comfort and costs you money: valuable heating energy is escaping to the outside while continuous draughts are unpleasant and are driving up your heating bills. A possible cause could be hardened or even an absence of gaskets.



- **The paper tears or stretches when pulled out.**

Your window gaskets sit and perform properly around the full perimeter: cold air stays outside, warm air inside. Not only does that benefit the indoor living climate, it also has a positive impact on heating bills.

Check with roller mushroom head bolts.

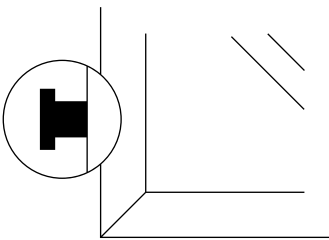

Pick up the roller mushroom head bolt and compare it with the bolts and locking parts on your window.

Security and user comfort: How many bolts and locking parts can you find?



- **Bolts without mushroom head geometry**

No protection: your window can be prised open in 10 seconds. If the bolt cannot be turned around its own axis like the sample roller mushroom head bolt, then it will be difficult to operate the handle.



- **At least two roller mushroom head bolts**

Basic burglary protection: the modern standard requires two roller mushroom head bolts which hook firmly into the recess of the solid security locks. This combination reliably locks the windows and makes it difficult to prise them open.



- **Multi-point locking and safety glass**

High burglary protection: for averagely sized modern windows, up to nine locking points and solidly bonded laminated safety glass provide maximum security. This level of security makes break-ins virtually impossible.

Check with material sample.

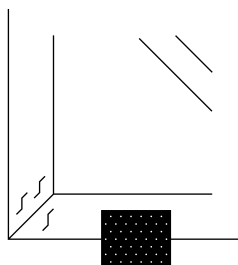

Pick up the enclosed material sample – this is how perfect a finish can look. How do your windows compare?

Visual condition:
Does your window have visible defects?



● **Peeling paint and cracks**

If wooden windows are not regularly sanded down and painted or stained, then the material will be attacked by wind and weather. The paint will peel off, with cracking and rot as the upshot.



● **Condensation**

The poorer the insulation performance of the glazing, the colder the glass surface compared to the indoor temperature – with condensation as the result. This may cause mould formation and rotting of the frame. Regular condensation on an aluminium frame is a sign that it offers poor thermal insulation performance.



● **Well-maintained condition**

There is no weather-induced peeling paint and patches of mould or rot. The surface is well-maintained and thus largely weathertight.

How good are your present windows? Results of Window-Check.

● **Take immediate action!**

Did you see dark red in your answers – once or even several times? Then it is high time to act: your windows are outdated, do not meet present-day quality standards and may pose a real security risk.

● **Some things need doing!**

Modern, better sealed windows will boost living quality and security while cutting heating costs. Your windows may function, but there is ample scope for improvement, especially in terms of tightness and burglary protection.

● **Are you looking for something better?**

Your windows meet present-day standards – but better options are, of course, still available. Would you like more comfort? Or are you dissatisfied with how your windows look? Then you already have two good reasons to consider replacing them.

What is the next step?

You now know what condition your windows are in. And have a host of questions: just how leaky are my windows? When do old windows become a serious security risk? What are the arguments for and against a replacement? How fast and clean is such a replacement? And, of course: what can I do now? It's easy – take the next step: arrange for on-the-spot expertise and counselling! We will come to you, check your windows, answer your questions and give you advice. Free of charge and with no obligation.

Installation

→ Installation procedure

Always transparent and professional.

We ensure that every step of the installation process is clear and intelligible. Our good-practice installation of your new windows has been certified by the Institut für Fenstertechnik (ift) Rosenheim.

This is how window replacement works at Finstral:



1. Dates for delivery and installation

We will agree binding dates with you a few weeks in advance.



5. Instructions on operation

The installer will explain how your new windows work and hand over the operating and safety instructions.



2. Discussion of work procedure

The installer will arrive at the agreed time and establish the work procedure in consultation with you.



6. Acceptance and commencement of warranty

The installer will present you with the acceptance form. If you are satisfied, you can sign this. That will then mark the commencement of your warranty period.



3. Protection of floors and furniture

We will put in place the necessary covering materials to prevent any soiling or damage to your interior.



7. Invoice and declaration of performance

Prompt and transparent – upon contract completion, you will receive the final invoice and declaration of performance for your order.



4. Good-practice installation

Windows are always fitted in accordance with the guidelines issued by Finstral and the Institut für Fenstertechnik (ift) Rosenheim.



8. Return of old windows

On request, we will pick up your old windows after replacement and arrange for proper recycling.

Always installed in accordance with good practice, as certified by the annual quality audits of the Institut für Fenstertechnik (ift) Rosenheim. We will handle every step – from agreeing the installation date to protecting your furniture during the works and disposing of the old windows.



FINSTRAL
Institut für Fenstertechnik
Rosenheim
ZERTIFIZIERT

Certified assembly professional

Acceptance

Clear, correct, transparent.

This is how Finstral operates – from the initial counselling session to acceptance of the completed works and payment.



Invoicing and declaration of performance.

We will, of course, provide you with a prompt and transparent invoice and are always personally available to answer any queries you may have. You will also receive a declaration of performance along with the invoice. In this, we document the performance features of your new windows and doors.

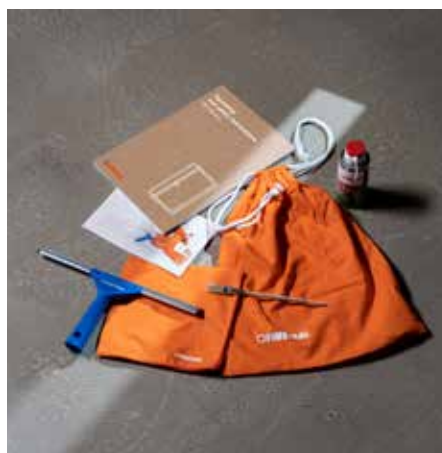

Acceptance and instruction.

Final quality control and acceptance are of course carried out together with you. This also gives you the opportunity to clarify any further points on the operation and maintenance of the windows.



Detailed operating instructions.

Upon completion of the installation works, the installer will present you with the operating instructions, which contain exhaustive descriptions of all the functions of your new windows, doors and glass walls. Here you will also find guidance on care, maintenance and troubleshooting. You can take a look at finstral.com/manuals

Once installation has been completed, the installer will instruct you on all the functions of your new windows.



Warranties/Certificates
Customer service
Architect service
Sustainability



Warranties/Certificates → Product quality

Always certified quality.

Not only can we confidently assert the quality of our products and services, we can also supply evidence in the form of quality marks and certificates – of which we can offer more than any other European window manufacturer. Are you interested in the full details?

Then please contact us at finstral.com/contact

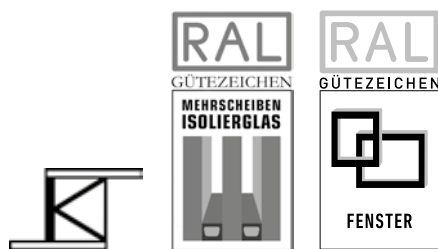

RAL quality mark for uPVC window profiles, multi-pane insulation glass, windows

The RAL quality label defines and guarantees product quality and its verifiable quality control.



CEKAL quality certification for insulation glass

The CEKAL certification for insulation glass defines and guarantees product quality and its verifiable quality control.



QB quality mark for uPVC profiles

The QB quality mark for uPVC window profile systems defines and guarantees product quality and its verifiable quality control.



“Vinyl Verified” label for uPVC quality

The VinylPlus® “Vinyl Verified” product label testifies to outstanding achievements in terms of sustainable development for companies in the uPVC construction industry.



Qualicoat Seaside certification for aluminium coating

Coated aluminium finishes meet the requirements of the Association for Quality Control in the Lacquering, Painting and Coating Industry for protection against aggressive environmental influences such as exhaust gases or salty air in coastal areas.



Health-related evaluation of VOC emissions from construction products

The construction product meets the required conditions and is suitable for use in building interiors from a health point of view.



Passive House Institute certificate for FIN-Window Nova-line 90

Our FIN-Window Nova-line 90 window has been certified by the Passive House Institute for warm-temperate climate zones.



Certified ift-quality windows

The ift-quality mark certifies the fitness for use and long-term performance of our profile systems, including all components (glass, hardware, gaskets etc.), for above-average exposure. It is regularly checked and renewed.



Certified ift-quality doors

The ift-quality mark certifies the fitness for use and long-term performance of our door systems, including all components (infill panels, hardware, gaskets etc.), for above-average exposure.



Always guaranteed performance.

At Finstral, every window is perfect. Durable and colour-fast. And, in the event of any defects, you can of course fall back on extensive warranties that cover every component of your window. Many of our warranty services even go beyond the minimum statutory requirements.

Warranties/Certificates → Service and process quality

Always of the highest standard.

Our service and process quality also ranks among the best-certified in the industry. We arrange for continuous checks and certification to ensure long-term compliance with high quality standards.

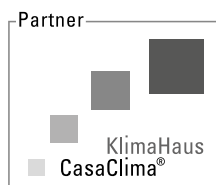

CasaClima partner.

A CasaClima partner excels by high quality in its area of expertise and a commitment to sustainability in business.



Certified installation expert.

Installation partners with this label have received instruction in workmanship by Finstral and the Institut für Fenstertechnik (ift) Rosenheim. The standard of workmanship of these companies is independently audited every year.



Quality management to ISO 9001.

Meeting the highest requirements is not limited to the development and manufacture of products, but is the principle behind all our operations. The various divisions of Finstral's work organisation are checked for quality capability under the certified quality management system to ISO 9001.



Occupational safety to ISO 45001.

Everyone working at Finstral must have a safe workplace – to that we are committed. Accordingly, we make no compromises with regard to inspection: we certify the continuous and preventive improvement of occupational safety throughout the company in accordance with ISO 45001.



Environmental management to ISO 14001.

We care very strongly about the sustainable use of resources. The certified environmental management system to ISO 14001 vouches for the continuous and preventive improvement of the company's environmentally oriented services.



Energy management to ISO 50001.

Our windows help to save energy. But we at Finstral also conserve valuable resources by consistently working to reduce our own energy demand. The certified energy management system to ISO 50001 vouches for the continuous optimisation of energy consumption in all plants and administrative buildings.

From Finstral, you will receive a building connection drawing for each installation situation together with specifications on the installation procedure and materials. We have the largest library of building connection drawings in Europe, numbering around 1,000, some 400 of which have been certified by the Institut für Fenstertechnik (ift) Rosenheim.

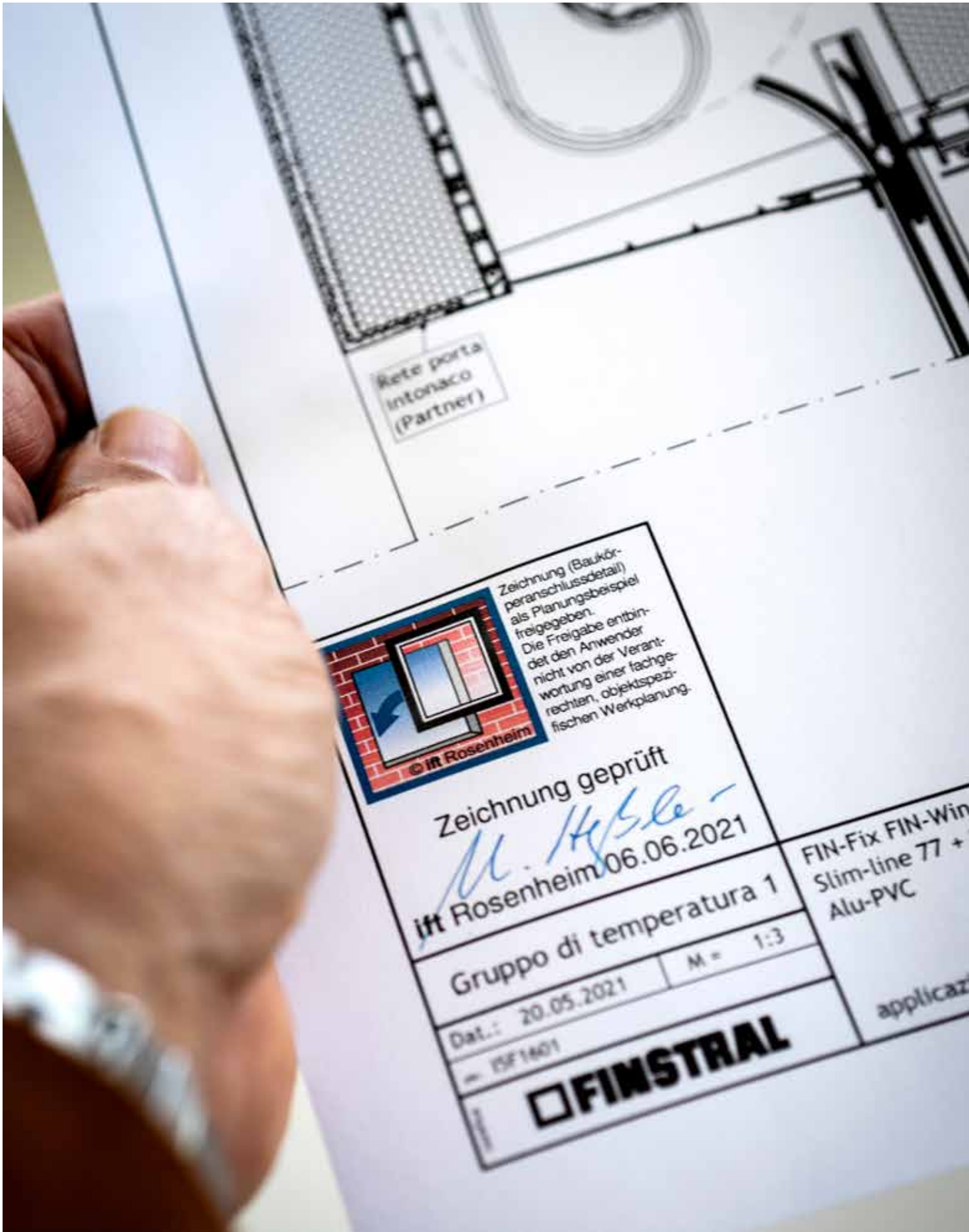

Rete porta
Intonaco
(Partner)



Zeichnung (Baukörperanschlussdetail) als Planungsbeispiel freigegeben.
Die Freigabe entbindet den Anwender nicht von der Verantwortung einer fachgerechten, objektspezifischen Werkplanung.

Zeichnung geprüft
M. Hübner
ift Rosenheim 06.06.2021

Gruppo di temperatura 1
M = 1:3

Dat.: 20.05.2021
- ISF1601

FINSTRAL

FIN-Fix FIN-Win
Slim-line 77 +
Alu-PVC

applicaz

Customer service

We are always at your side.

Windows are in service for decades. And, naturally enough, the occasional query may arise during this period. That is also something we are glad to handle – with forward-looking planning and our own in-house service centre. This has provided our customers with reliable support for over 50 years.



Identification number.

Every Finstral window has an identification number. Finstral stores all product and order data to allow tracing at all times. As a result, we always have all information at hand should you ever have a query.



Generally low maintenance.

Finstral pays particular attention to designing its windows for low maintenance. For example, as we incorporate bonded sashes and sash lifters as standard, window sashes only very rarely sag and hardly ever require adjustment.

**Spare parts available.**

In the manufacture of our windows, we always provide for their optimum recyclability after use. To ensure that this time is as far in the future as possible, we supply you, even decades later, with spare parts for your window to cover most repairs.

**In-house service centres throughout Europe.**

You can also depend on us after installation. Finstral operates an in-house customer service centre in all its sales regions. This enables us to support our dealer partners and ensure that you are never left on your own should problems arise with the performance of our products.

Do you have any queries?
[finstral.com/contact](https://www.finstral.com/contact)

Architect service

Always the best service for great ideas.

We also offer architects exactly what they expect. From building connection drawings and product data sheets to CAD data in DWG format, you can obtain all the details you need from Finstral's Architect Service or directly from the Architect Service portal.

More information can be found under finstral.com/architectservice

Everything about the product.

Single-family house? Company headquarters? Refurbishment of an urban villa? Precise design work requires accurate information. We will provide you with everything you need to know about Finstral products for every stage of design.

Everything for the design.

Our windows are always custom-made in accordance with your specifications. We will support you with know-how and experience in all your design detailing to ensure that you find the perfect solution for every project.

Expert advice.

Cultivating personal contacts is particularly important for us. Our own planning consultants are at hand – even with a visit to your site – to provide you with advice and support from the initial stages of design to installation.

Come and see Finstral first-hand.

Finstral always acts as a single-source provider. You can experience this live on our premises: why not come to one of our Studios, take a factory tour or join us on a visit to one of our reference projects?

Whether through a visit to a Finstral Studio, a guided factory tour or participation in one of our architecture salons – we offer architects numerous opportunities to get to know us.



Whether single-family home, holiday villa, office building or housing estate; whether new-build, refurbishment or wholesale alteration subject to strict architectural conservation provisions; whether proven standard solution produced in large numbers or a custom-made product: wherever windows and doors are needed, Finstral will always deliver the perfect product, always a tailored creation. And, to back this up, the Finstral Architect Service will always offer professional advice and support in a spirit of partnership. We are well-equipped to deal with design and construction projects in all their diversity together with virtually all associated challenges: this is borne out by the following statements made by architects about their collaboration with Finstral.

“We also have Finstral to thank for the built result.”



Plenty of glass on the beach.

Eleven generously glazed, individually configured apartments – directly on the beach.

Full reference report:

finstral.com/residence-torremolinos

“Finstral helped us a lot. From the very outset, they gave us constructive, professional support on all our questions and delivered optimum solutions to all problems regarding window size, dimensions and installation. To a large extent, we owe the built result and its impact to Finstral.”

Iván Faltoyano, Eido Arquitectura, on a new-build residential facility in Torremolinos (Spain)



“Finstral built sample windows for us: we normally adopt this procedure for larger projects when we are installing hundreds of windows. [...] But it was important for us to see whether everything was a good match – from colour to installation. [...] The collaboration was also very constructive because Finstral was open to new ideas and able to develop innovative solutions.”

Yves Dreier, Dreier Frenzel, on a densification project with sophisticated fenestration and matching doors in Renens (Switzerland)

The triangular building.

A triangular sloping site and limited budget as the starting point – an architectural award as the outcome.

Full reference report:
finstral.com/renens

Conversion instead of new-build.

Challenging refurbishment subject to architectural conservation provisions – incorporating a whole series of custom-manufactured windows.

Full reference report:
finstral.com/landauarena

“Very often you have to work together in the search for new solutions. That is why close collaboration with manufacturers is so important. Finstral is highly flexible in this respect. It develops ideas of its own and, because it produces its windows completely in-house, can turn many things into reality.”

Thorsten Holch, Archimedes, on the conversion of a former horse stable and other adaptive use schemes in Landau (Germany)





“The house is a blend of aesthetics and functional performance with a maximum of technology. Given that direct contact with the lake was our top priority, Finstral windows became the decisive architectural design element.”

Matteo Brighenti on a new-build holiday home in Torri del Benaco (Italy)

Lakeside house.

Designed with glass, directly on the Lake Garda shoreline – frameless window walls with all-glass corners.
Full reference report:
finstral.com/lakegarda

A perfectly fitting vertical extension.

As distinctive as a rock formation – a project in the historic core of Graz featuring extra-large window areas.
Full reference report:
finstral.com/wildermann-graz

“Finstral has the advantage of being able to manufacture relatively lightweight windows with comparatively narrow profiles that offer high stability. Moreover, at penthouse level, we have floor-to-ceiling heights of over four metres, with very tall windows in the roof gables as a result. And there are not many manufacturers who can make and install specially required products to such a high standard.”

Mark Jenewein, LOVE architecture, on a complex window assembly in Graz (Austria)





A hotel that speaks two languages.
 The "NH Milano Corso Buenos Aires" in the Alcor building complex combines the historicist with the modern aesthetic – and, set in the heart of Milan city centre, imposes the utmost functional demands on the windows (e.g. sound insulation). Full reference report: finstral.com/nhhotel

“We were convinced by the consistent modularity of the Finstral range: this is because it uses tailor-made products to provide customised solutions. It allowed us to craft windows featuring a blend of modern and historical architectural language.”

Edoardo Ticozzi, Studio Pola, on the spectacular combination of new-build and refurbishment for a hotel in Milan (Italy)

Sustainability

This is how sustainably Finstral works.

Finstral's innovative windows are inherently sustainable on account of their decisive contribution to insulating the building envelope – and therefore to reduce energy consumption and carbon emissions, which is particularly important in the residential sector. Quite apart from that, however, Finstral sets itself ambitious goals as a company and pursues these single-mindedly with the aim of achieving comprehensive, across-the-board sustainability. Always transparent, always quantifiable.



Keeping an eye on everything.

Anyone seeking an effective and lasting reduction in environmental pollution needs to know as exactly as possible where this arises. This is why Finstral works with the Environmental Impact Board, which systematically records all emissions and their sources in the company and its surrounds – along with our sustainability measures and progress.



Carbon reduction.

Though there is still much to do, we have already achieved a fair amount. By gradually switching production to green electricity, using district heating and boosting efficiency, Finstral's carbon emissions – excluding transportation – were already significantly cut by 78 percent between 2012 and 2022.



Using the sun.

South Tyrol, Italy, southern Germany: many Finstral sites enjoy frequent and intense sunshine. Which is ideal for generating our own electricity by means of rooftop photovoltaic systems! From 2025 onwards, the proportion of our electricity from this and other renewable sources will run to at least 20 percent.



uPVC recycling.

uPVC offers many advantages for window construction. One of these is the material's outstanding recyclability. The proportion of recycled uPVC granulate in our uPVC production currently runs to 23%.

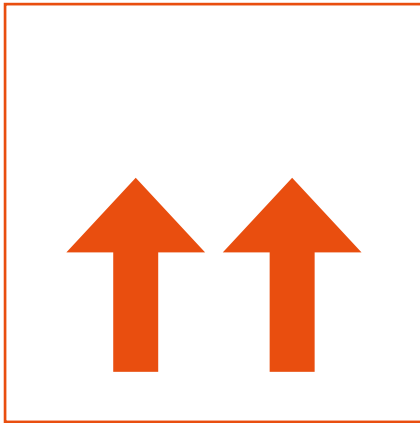

Eco-efficient transportation.

Our logistics and delivery operations depend on the use of trucks. Through the use of biodiesel, gas and electric vehicles, we are making every effort to minimise our carbon intensity.



To zero by 2030.

Our entire production at 14 plants in Europe; all our buildings – including the 27 Finstral Studios; the entire vehicle fleet with all the trucks that transport materials and products for us; and generation of the energy consumed by Finstral every day: by 2030, all of these will be subject to climate-neutral operation – i.e. with a carbon profile of 0 t.



Faster and lower-impact installation.

Sustainability means conserving resources – also in relation to working time, material consumption and building fabric.

Replacement in next to no time.

Of paramount importance in achieving climate targets is the replacement of as many old and poorly insulated windows as possible. No other manufacturer can achieve this as quickly and with as little impact as Finstral: our certified slide-on and slide-in installation methods use the existing frame as the connection to the masonry – thereby allowing replacement at a rate of around one to two hours per window!

Smarter installation.

Windows are still installed in new buildings at far too early a stage: when site works are still in progress, damage and soiling are almost inevitable. A two-stage procedure, as practised by Finstral, is far more intelligent. First, a mounting frame is built into the masonry. The finished windows are then inserted only shortly before completion of the construction works. Incidentally, this also enormously facilitates any later replacement of the window. What could be more sustainable?

More information can be found under [Centre → Building connection](#)



More efficient production.

On the one hand, we significantly expanded our manufacturing operations between 2012 and 2022, bringing new production lines, a new glass kiln and a new powder-coating facility into operation. On the other hand, energy demand was significantly cut, by 23 percent, within the same period.

Windows are our life: the Finstral family business.

“I originally thought windows were boring,” said Hans Oberrauch (†) – the man who founded Finstral in 1969. “But the opposite has turned out to be the case. Windows are a never-ending story.” The headquarters are to this very day located at the place where everything began – in Unterinn am Ritten, near Bozen in South Tyrol, Italy. It was from here that Hans, together with his brother Luis, built the company to its present size: with 14 plants, over 1,600 employees, 27 company-owned Finstral Studios and some 900 builders’ merchant partners in 14 countries, Finstral now ranks as one of Europe’s leading manufacturers of windows, doors and glass walls.

Apart from a passion for delivering the perfect product, a tradition of entrepreneurial responsibility also continues. Finstral is still fully owned by the family. With Joachim, Florian, Verena and Kristin Oberrauch, the children of Hans and Luis have taken over the operational management – and are heavily involved in day-to-day operations, from development and production to the management of key markets.



Windows are a never-ending story – and, at Finstral, an intergenerational one.
From left to right: Florian, Kristin, Luis, Hans (†), Verena, Joachim Oberrauch.

At home in South Tyrol, leaders in Europe: the company headquarters in Unterinn.



Always from a single source: production at Finstral

Ever since its foundation over 50 years ago, Finstral has been guided by a conviction that has proved to be a real key to success: if you want something done, do it yourself. That is the only way, after setting a high bar for quality standards, of always meeting them. From development, material processing and manufacture to delivery, installation ... and recycling: everything needed for a Finstral window in its finished state always comes from a single source – from us.



Video of
factory tour



Far more valuable than it looks:
uPVC offcut from our production
in Kurtatsch (South Tyrol/Italy),
which is processed in our own
recycling plant.

1. Circular economy

Finstral produces hardly any waste. Only raw materials instead. That is because we process and reuse almost all the material left over from production: the proportion of recycled uPVC used in the extrusion of our uPVC profiles is already 20 percent. We are also systematically adapting our aluminium profile powder-coating operations to the processing of secondary aluminium. During glazing production, only very little offcut remains after cutting the panes to size. This residue is nonetheless returned to the supplier for recycling. We also accept old windows after replacement, dismantle these and recycle as much of them as possible. And thanks to their modular design, our products can be separated into pure, unmixed components at the end of their long life-cycle – and completely recycled.



Similar working principle to a pasta press: extrusion of a uPVC profile at our plant in Kurtatsch (South Tyrol/Italy).

2. uPVC profile extrusion

At Finstral, we develop and extrude all frame profiles ourselves. Yes, that takes considerable effort – but it pays dividends for us and our customers. This is the only way we can ensure that our own relentlessly high-quality uPVC formulation and the profiles it is used to manufacture translate into a perfect window system – with features that include a high-grade finish directly produced during extrusion, the narrowest of frames – and a modular product variety in which virtually everything is combinable with everything else.

3. Aluminium powder coating

Finstral offers over 250 aluminium colours in its range. To ensure the maximum durability of each of these on our frame facings, the edges and corners, for example, require extra-thick paint application. So we also took complete control of this process, set up a powder-coating facility and gained the necessary credentials to operate as a “chemical processing company”, certified by the Qualicoat Seaside label: this confirms that we meet all requirements for providing protection against aggressive environmental actions. This is the only way to keep on learning and improving ... and now we can also finish window and door handles in any required colour.

As filigree as a liana: careful powder coating of covering profiles at our plant in Borgo Valsugana (Trentino/Italy). Here we use 120 different colour finishes every week.



4. High-bay warehouse

Finstral produces the most varied selection of windows, doors and glass walls in Europe: 650,000 units a year, in 14 plants in Italy and Germany. Each order represents a custom creation based on tailored measurements, materials, colours and functions. Our storeroom is the high-bay warehouse: this is where all uPVC and aluminium profiles needed for manufacture are kept in six-metre-deep drawers. They are assembled and dispatched in such a way that all components needed for production are made available “just in time”.

Stowed away, rearranged and retrieved by the robot – day and night: view of our high-bay warehouse in Kurtatsch (South Tyrol/Italy).



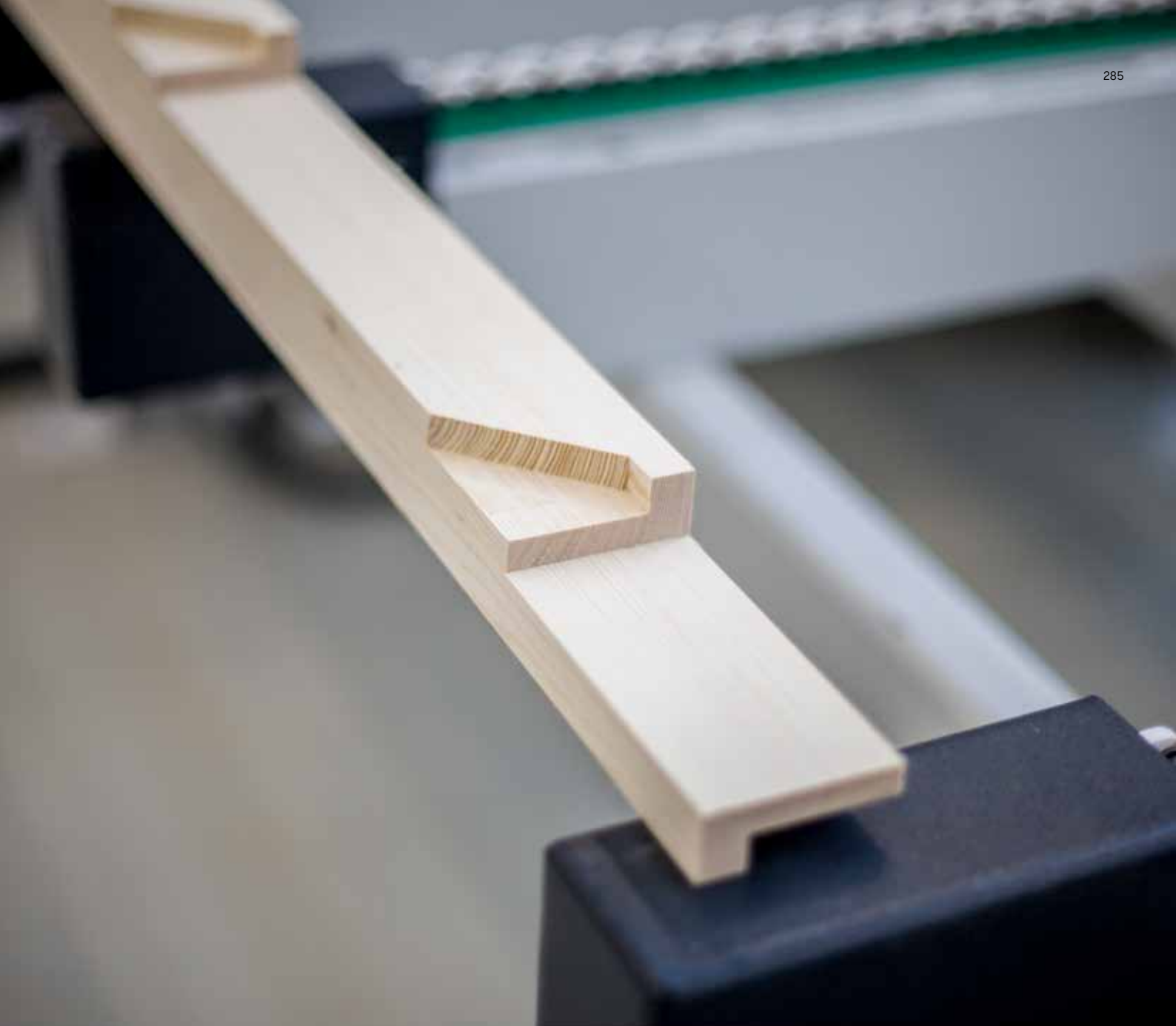

Crafted with meticulous workmanship and mechanical precision: milling of real-wood facing at our woodworking plant in Oppeano (Verona/Italy).

5. Woodworking

Finstral founder Hans Oberrauch comes from a family of carpenters. We have now revitalised this expertise: since 2017, we have ourselves manufactured all real-wood frame facings from board products. We only process wood from sustainable forestry – and this very sparingly.

And the fact that we only use this valuable material in the weather-sheltered interior also allows gentle treatments by applying water-soluble coatings or soft oiling. Wood remains real wood for the window's entire life-cycle ... without becoming hazardous waste.



Full transparency, without compromises: quality check at our glass factory in Gochsheim (Lower Franconia/Germany).

6. Insulation glass production

Finstral processes flat glass, the highest-quality glass type of all – a fact that becomes immediately “transparent” when the three-by-six-metre panes are delivered to our three state-of-the-art glass factories. We cut the glass to size and grind the edges; to improve fracture resistance, it is seamed and toughened in the kiln; depending on the design, it is also printed. Finally, we assemble the glass into optimum double- or triple-glazed insulating glass units – using high-grade, thermally insulated spacers with welded corners. A digital scanner then performs a rigorous check to ensure that not the slightest flaw is overseen.

7. Assembly

Each sash and frame is assembled from four individual profile components made from high-grade uPVC, with the corners welded at 260 degrees for extra-high stability and outstanding tightness. Hardware is installed in accordance with the specific requirements. At Finstral, the glass is always bonded in the sash; this is the only way of ensuring that the overall assembly meets the highest standards in terms of functional performance, user comfort and durability. Among window manufacturers, insertion of the sash in the frame is dubbed the “wedding”. And a full-scale quality test is performed prior to delivery.

The profiles are cut to size prior to assembly of the sash and frame to form the finished window – here in Scurelle (Trentino/Italy). Only then does the Finstral plant celebrate the “wedding”.



Range

With some 120 models in five materials and numerous colours, Finstral offers the widest range of windows in Europe. Here is an overview: windows, sliding and folding doors, window walls – the full variety offered by Finstral in tabular form.

Further details

Product data sheets, specification texts, CAD data, colour and material samples can be found at finstral.com/range

The environmental product declaration (EPD) for the most common frame models can be found at finstral.com/epd

More detailed information on the European product standard for windows and external doors can be found in our brochure, which can be ordered at finstral.com/prospectuses

U_w The thermal transmittance of a window indicates the loss of heat due to its transmission through the building element to outdoors. The lower the value, the more energy-efficient the building.

R_w Component-specific, single-number value for airborne sound insulation. The higher the value, the better the airborne sound insulation performance.

npd no performance determined

* offset on interior

** flush on interior

		uPVC windows					
Material	Exterior	uPVC					
	Centre	uPVC					
System (Construction depth)	Interior	uPVC					
		FIN-Window (77 mm)	FIN-Window (90 mm)		FIN-Window (124 mm)		
		U_w 1-sash (W/m ² K) with double/triple glazing U_w 2-sash (W/m ² K) with double/triple glazing with flying mullion R_w Standard (dB) / R_w best value (dB)					
Sash models	Classic-line	FIN-Window Classic-line 77 uPVC-uPVC	FIN-Window Classic-line 90 uPVC-uPVC		FIN-Window Classic-line 124 uPVC-uPVC		
		1.2 / 0.77 1.3 / 0.88	1.2 / 0.75	1.3 / 0.85	1.2 / 0.78	1.3 / 0.88	
		32 (-2;-6) / 45 (-1;-3)	32 (-2;-6) / 45 (-1;-3)		32 (-2;-6) / 45 (-1;-3)		
Classic-line Cristal							
Slim-line		FIN-Window Slim-line 77 uPVC-uPVC	FIN-Window Slim-line 90 uPVC-uPVC		FIN-Window Slim-line 124 uPVC-uPVC		
		1.2 / 0.77 1.3 / 0.87	1.2 / 0.74	1.3 / 0.84	1.2 / 0.77	1.3 / 0.87	
		32 (-2;-6) / 46 (-2;-5)	32 (-2;-6) / 46 (-2;-5)		32 (-2;-6) / 46 (-2;-5)		
Slim-line Twin		FIN-Window Slim-line Twin 77 uPVC-uPVC	FIN-Window Slim-line Twin 90 uPVC-uPVC		FIN-Window Slim-line Twin 124 uPVC-uPVC		
		0.97 / 0.83 1.0 / 0.92	0.97 / 0.83	1.0 / 0.92	0.97 / 0.83	1.0 / 0.92	
		42 (-3;-9) / 47 (-2;-5)	42 (-3;-9) / 47 (-2;-5)		42 (-3;-9) / 47 (-2;-5)		
Slim-line Cristal		FIN-Window Slim-line Cristal 77 uPVC-uPVC	FIN-Window Slim-line Cristal 90 uPVC-uPVC		FIN-Window Slim-line Cristal 124 uPVC-uPVC		
		- / 0.80 - / 0.92	- / 0.77	- / 0.92	- / 0.80	- / 0.93	
		39 (-2;-6) / 42 (-2;-5)	39 (-2;-6) / 42 (-2;-5)		39 (-2;-6) / 42 (-2;-5)		
Slim-line Cristal Twin		FIN-Window Slim-line Cristal Twin 77 uPVC-uPVC	FIN-Window Slim-line Cristal Twin 90 uPVC-uPVC		FIN-Window Slim-line Cristal Twin 124 uPVC-uPVC		
		1.1 / 0.89 1.2 / 1.0	1.0 / 0.83	1.1 / 0.97	1.1 / 0.86	1.2 / 1.1	
		npd	npd		npd		
Step-line		FIN-Window Step-line 77 uPVC-uPVC	FIN-Window Step-line 90 uPVC-uPVC		FIN-Window Step-line 124 uPVC-uPVC		
		1.2 / 0.78 1.3 / 0.89	1.2 / 0.75	1.3 / 0.85	1.2 / 0.78	1.3 / 0.88	
		32 (-2;-6) / 46 (-2;-5)	32 (-2;-6) / 46 (-2;-5)		32 (-2;-6) / 46 (-2;-5)		
Step-line Door		FIN-Window Step-line Door 77 uPVC-uPVC	FIN-Window Step-line Door 90 uPVC-uPVC		FIN-Window Step-line Door 124 uPVC-uPVC		
		1.2 / 0.84 1.3 / 0.98	1.2 / 0.81	1.2 / 0.93	1.2 / 0.81	1.3 / 0.93	
		npd	npd		npd		
Step-line Cristal							
Ferro-line							
Ferro-line Cristal							
Nova-line		FIN-Window Nova-line 77 uPVC-uPVC	FIN-Window Nova-line 90 uPVC-uPVC		FIN-Window Nova-line 124 uPVC-uPVC		
		1.2 / 0.80 1.2 / 0.89	1.1 / 0.76	1.2 / 0.85	1.2 / 0.78	1.2 / 0.89	
		36 (-2;-5) / 45 (-1;-3)	36 (-2;-5) / 45 (-1;-3)		36 (-2;-5) / 45 (-1;-3)		
Nova-line Plus		FIN-Window Nova-line Plus 77 uPVC-uPVC	FIN-Window Nova-line Plus 90 uPVC-uPVC		FIN-Window Nova-line Plus 124 uPVC-uPVC		
		- / 0.76 - / 0.86	- / 0.71	- / 0.83	- / 0.74	- / 0.83	
		35 (-2;-6) / 44 (-2;-5)	35 (-2;-6) / 44 (-2;-5)		35 (-2;-6) / 44 (-2;-5)		
Nova-line Twin		FIN-Window Nova-line Twin 77 uPVC-uPVC	FIN-Window Nova-line Twin 90 uPVC-uPVC		FIN-Window Nova-line Twin 124 uPVC-uPVC		
		1.1 / 0.93 1.1 / 1.0	1.0 / 0.90	1.1 / 0.98	1.1 / 0.93	1.1 / 1.0	
		40 (-2;-7) / 44 (-2;-7)	40 (-2;-7) / 44 (-2;-7)		40 (-2;-7) / 44 (-2;-7)		
Nova-line Cristal Twin		FIN-Window Nova-line Cristal Twin 77 uPVC-uPVC	FIN-Window Nova-line Cristal Twin 90 uPVC-uPVC		FIN-Window Nova-line Cristal Twin 124 uPVC-uPVC		
		1.1 / 0.91 1.3 / 1.1	1.1 / 0.88	1.2 / 1.0	1.1 / 0.93	1.3 / 1.1	
		npd	npd		npd		
Burglary protection		Standards	4 security locking points		4 security locking points		
Colour/Finish		Exterior	10 uPVC colours		10 uPVC colours		
		Interior	10 uPVC colours		10 uPVC colours		

uPVC-aluminium windows			Aluminium windows	Wood-aluminium windows	Inlay-aluminium windows
Aluminium			Aluminium	Aluminium	Aluminium
uPVC			uPVC	uPVC	uPVC
uPVC			Aluminium	Wood	Wood/ceramic/metal
FIN-Window (77+8 mm)	FIN-Window (90+8 mm)	FIN-Window (124+3 mm)	FIN-Project (78*/88 mm**)	FIN-Project (78*/95 mm**)	FIN-Project (78 mm**)
U_w 1-sash (W/m ² K) with double/triple glazing (Cristal only quadruple glazing) U_w 2-sash (W/m ² K) with double/triple glazing with flying mullion (Cristal only quadruple glazing)					
R_w Standard (dB) / R_w best value (dB)					
FIN-Window Classic-line 77+8 Aluminium-uPVC	FIN-Window Classic-line C&N 90+8 Aluminium-uPVC	FIN-Window Classic-line 124+3 Aluminium-uPVC	FIN-Project Classic-line 78/88 Aluminium-aluminium	FIN-Project Classic-line 78/95 Aluminium-wood	FIN-Project Classic-line 78 Aluminium-wood/ceramic/metal
1.2 / 0.77 1.3 / 0.88	1.2 / 0.75 1.3 / 0.85	1.2 / 0.78 1.3 / 0.88	1.2 / 0.77 1.3 / 0.91	1.2 / 0.77 1.3 / 0.91	1.2 / 0.77 1.3 / 0.91
32 (-2;-6) / 45 (-1;-3)	32 (-2;-6) / 45 (-1;-3)	32 (-2;-6) / 45 (-1;-3)	32 (-2;-6) / 44 (-1;-4)	32 (-2;-6) / 44 (-1;-4)	38 (-2;-6) / 44 (-1;-4)
			FIN-Project Classic-line Cristal 78/88 Aluminium-aluminium	FIN-Project Classic-line Cristal 78/95 Aluminium-wood	FIN-Project Classic-line Cristal 88 Aluminium-wood/ceramic/metal
			- / 0.76 - / 0.92	- / 0.76 - / 0.92	- / 0.76 - / 0.92
			npd	npd	npd
FIN-Window Slim-line 77+8 Aluminium-uPVC	FIN-Window Slim-line C&N 90+8 Aluminium-uPVC	FIN-Window Slim-line 124+3 Aluminium-uPVC	FIN-Project Slim-line 78/88 Aluminium-aluminium	FIN-Project Slim-line 78/95 Aluminium-wood	FIN-Project Slim-line 78 Aluminium-wood/ceramic/metal
1.2 / 0.77 1.3 / 0.87	1.2 / 0.74 1.3 / 0.84	1.2 / 0.77 1.3 / 0.87	1.2 / 0.77 1.3 / 0.91	1.2 / 0.77 1.3 / 0.91	1.2 / 0.77 1.3 / 0.91
32 (-2;-6) / 46 (-2;-5)	32 (-2;-6) / 46 (-2;-5)	32 (-2;-6) / 46 (-2;-5)	38 (-2;-6) / 44 (-1;-4)	38 (-2;-6) / 44 (-1;-4)	38 (-2;-6) / 44 (-1;-4)
FIN-Window Slim-line Twin 77+8 Aluminium-uPVC	FIN-Window Slim-line Twin C&N 90+8 Aluminium-uPVC	FIN-Window Slim-line Twin 124+3 Aluminium-uPVC	FIN-Project Slim-line Twin 78/88 Aluminium-aluminium	FIN-Project Slim-line Twin 78/95 Aluminium-wood	FIN-Project Slim-line Twin 78 Aluminium-wood/ceramic/metal
0.97 / 0.83 1.0 / 0.92	0.97 / 0.83 1.0 / 0.92	0.97 / 0.83 1.0 / 0.92	1.1 / 0.98 1.3 / 1.1	1.1 / 0.92 1.2 / 1.1	1.1 / 0.98 1.3 / 1.1
42 (-3;-9) / 47 (-2;-5)	42 (-3;-9) / 47 (-2;-5)	42 (-3;-9) / 47 (-2;-5)	38 (-3;-8) / 45 (-1;-6)	38 (-3;-8) / 45 (-1;-6)	38 (-3;-8) / 45 (-1;-6)
FIN-Window Slim-line Cristal 77+8 Aluminium-uPVC	FIN-Window Slim-line Cristal C&N 90+8 Aluminium-uPVC	FIN-Window Slim-line Cristal 124+3 Aluminium-uPVC	FIN-Project Slim-line Cristal 78/88 Aluminium-aluminium	FIN-Project Slim-line Cristal 78/95 Aluminium-wood	FIN-Project Slim-line Cristal 78 Aluminium-wood/ceramic/metal
- / 0.80 - / 0.92	- / 0.77 - / 0.92	- / 0.80 - / 0.93	- / 0.76 - / 0.92	- / 0.76 - / 0.92	- / 0.76 - / 0.92
39 (-2;-6) / 42 (-2;-5)	39 (-2;-6) / 42 (-2;-5)	39 (-2;-6) / 42 (-2;-5)	npd	npd	npd
FIN-Window Slim-line Cristal Twin 77+8 Aluminium-uPVC	FIN-Window Slim-line Cristal Twin C&N 90+8 Aluminium-uPVC	FIN-Window Slim-line Cristal Twin 124+3 Aluminium-uPVC	FIN-Project Slim-line Cristal Twin 78/88 Aluminium-aluminium	FIN-Project Slim-line Cristal Twin 78/95 Aluminium-wood	FIN-Project Slim-line Cristal Twin 78 Aluminium-wood/ceramic/metal
1.1 / 0.89 1.2 / 1.0	1.0 / 0.83 1.1 / 0.97	1.1 / 0.86 1.2 / 1.1	- / 0.91 - / 1.1	- / 0.88 - / 1.0	- / 0.91 - / 1.1
npd	npd	npd	40 (-3;-10) / 42 (-3;-9)	40 (-3;-10) / 42 (-3;-9)	40 (-3;-10) / 42 (-3;-9)
FIN-Window Step-line 77+8 Aluminium-uPVC	FIN-Window Step-line C&N 90+8 Aluminium-uPVC	FIN-Window Step-line 124+3 Aluminium-uPVC	FIN-Project Step-line 78/88 Aluminium-aluminium	FIN-Project Step-line 78/95 Aluminium-wood	FIN-Project Step-line 78 Aluminium-wood/ceramic/metal
1.2 / 0.78 1.3 / 0.89	1.2 / 0.75 1.3 / 0.85	1.2 / 0.78 1.3 / 0.88	1.2 / - 1.3 / -	1.2 / - 1.3 / -	1.2 / - 1.3 / -
32 (-2;-6) / 46 (-2;-5)	32 (-2;-6) / 46 (-2;-5)	32 (-2;-6) / 46 (-2;-5)	38 (-2;-6) / 40 (-3;-8)	38 (-2;-6) / 40 (-3;-8)	38 (-2;-6) / 40 (-3;-8)
FIN-Window Step-line Door 77+8 Aluminium-uPVC	FIN-Window Step-line Door 90+8 Aluminium-uPVC	FIN-Window Step-line Door 124+3 Aluminium-uPVC			
1.2 / 0.84 1.3 / 0.98	1.2 / 0.81 1.2 / 0.93	1.2 / 0.81 1.3 / 0.93			
npd	npd	npd			
			FIN-Project Step-line Cristal 78/88 Aluminium-aluminium	FIN-Project Step-line Cristal 78/95 Aluminium-wood	FIN-Project Step-line Cristal 78 Aluminium-wood/ceramic/metal
			- / 0.82 - / 0.98	- / 0.82 - / 0.98	- / 0.82 - / 0.98
			40 (-2;-6) / 42 (-2;-6)	npd	40 (-2;-6) / 42 (-2;-6)
			FIN-Project Ferro-line 78/88 Aluminium-aluminium	FIN-Project Ferro-line 78/95 Aluminium-wood	FIN-Project Ferro-line 78 Aluminium-wood/ceramic/metal
			1.2 / 0.77 1.3 / 0.91	1.2 / 0.77 1.3 / 0.91	1.2 / 0.77 1.3 / 0.91
			38 (-2;-6) / 44 (-1;-4)	38 (-2;-6) / 44 (-1;-4)	38 (-2;-6) / 44 (-1;-4)
			FIN-Project Ferro-line Cristal 78/88 Aluminium-aluminium	FIN-Project Ferro-line Cristal 78/95 Aluminium-wood	FIN-Project Ferro-line Cristal 78 Aluminium-wood/ceramic/metal
			- / 0.76 - / 0.92	- / 0.76 - / 0.92	- / 0.76 - / 0.92
			npd	npd	npd
FIN-Window Nova-line 77+8 Aluminium-uPVC	FIN-Window Nova-line C&N 90+8 Aluminium-uPVC	FIN-Window Nova-line 124+3 Aluminium-uPVC	FIN-Project Nova-line 78/88 Aluminium-aluminium	FIN-Project Nova-line 78/95 Aluminium-wood	FIN-Project Nova-line 78 Aluminium-wood/ceramic/metal
1.2 / 0.80 1.2 / 0.89	1.1 / 0.76 1.2 / 0.85	1.2 / 0.78 1.2 / 0.89	1.2 / 0.82 1.3 / 0.94	1.2 / 0.79 1.2 / 0.90	1.2 / 0.82 1.3 / 0.94
36 (-2;-5) / 45 (-1;-3)	36 (-2;-5) / 45 (-1;-3)	36 (-2;-5) / 45 (-1;-3)	38 (-2;-6) / 41 (-3;-7)	38 (-2;-6) / 41 (-3;-7)	38 (-2;-6) / 41 (-3;-7)
FIN-Window Nova-line Plus 77+8 Aluminium-uPVC	FIN-Window Nova-line Plus C&N 90+8 Aluminium-uPVC	FIN-Window Nova-line Plus 124+3 Aluminium-uPVC	FIN-Project Nova-line Plus 78/88 Aluminium-aluminium	FIN-Project Nova-line Plus 78/95 Aluminium-wood	FIN-Project Nova-line Plus 78 Aluminium-wood/ceramic/metal
- / 0.76 - / 0.86	- / 0.71 - / 0.83	- / 0.74 - / 0.83	1.2 / 0.77 1.3 / 0.91	1.2 / 0.77 1.3 / 0.91	1.2 / 0.77 1.3 / 0.91
35 (-2;-6) / 44 (-2;-5)	35 (-2;-6) / 44 (-2;-5)	35 (-2;-6) / 44 (-2;-5)	36 (-2;-6) / 43 (-2;-6)	36 (-2;-6) / 43 (-2;-6)	36 (-2;-6) / 43 (-2;-6)
FIN-Window Nova-line Twin 77+8 Aluminium-uPVC	FIN-Window Nova-line Twin C&N 90+8 Aluminium-uPVC	FIN-Window Nova-line Twin 124+3 Aluminium-uPVC	FIN-Project Nova-line Twin 78/88 Aluminium-aluminium	FIN-Project Nova-line Twin 78/95 Aluminium-wood	FIN-Project Nova-line Twin 78 Aluminium-wood/ceramic/metal
1.1 / 0.93 1.1 / 1.0	1.0 / 0.90 1.1 / 0.98	1.1 / 0.93 1.1 / 1.0	1.1 / 0.98 1.2 / 1.1	1.1 / 0.92 1.1 / 1.0	1.1 / 0.98 1.2 / 1.1
40 (-2;-7) / 44 (-2;-7)	40 (-2;-7) / 44 (-2;-7)	40 (-2;-7) / 44 (-2;-7)	40 (-2;-8) / 45 (-3;-10)	40 (-2;-8) / 45 (-3;-10)	40 (-2;-8) / 45 (-3;-10)
FIN-Window Nova-line Cristal Twin 77+8 Aluminium-uPVC	FIN-Window Nova-line Cristal Twin C&N 90+8 Aluminium-uPVC	FIN-Window Nova-line Cristal Twin 124+3 Aluminium-uPVC	FIN-Project Nova-line Cristal Twin 78/88 uPVC-uPVC	FIN-Project Nova-line Cristal Twin 78/95 uPVC-uPVC	FIN-Project Nova-line Cristal Twin 78 Aluminium-wood/ceramic/metal
1.1 / 0.91 1.3 / 1.1	1.1 / 0.88 1.2 / 1.0	1.1 / 0.93 1.3 / 1.1	- / 0.90 - / 1.1	- / 0.90 - / 1.1	- / 0.90 - / 1.1
npd	npd	npd	40 (-3;-10)	40 (-3;-10)	40 (-3;-10)
4 security locking points	4 security locking points	4 security locking points	Perimeter security locking points at most every 850 mm	Perimeter security locking points at most every 850 mm	Perimeter security locking points at most every 850 mm
252 aluminium colours	252 aluminium colours	252 aluminium colours	252 aluminium colours	252 aluminium colours	252 aluminium colours
10 uPVC colours	10 uPVC colours	10 uPVC colours	252 aluminium colours	6 softwood colours, 9 hardwood colours	5 precious wood finishes, 5 metal finishes, 12 ceramic finishes

		Sliding doors and windows				Lift-and-slide doors and windows			
Material	Exterior	uPVC	Aluminium	uPVC	Aluminium	Aluminium	Aluminium	Aluminium	Aluminium
	Centre	uPVC	uPVC	uPVC	uPVC	Aluminium	Aluminium	Aluminium	uPVC
	Interior	uPVC	uPVC	uPVC	uPVC	Aluminium	Aluminium	Aluminium	Wood
System (Construction depth)		FIN-Scroll (144 mm)	FIN-Scroll (156 mm)	FIN-Slide (160 mm)	FIN-Slide (157/168 mm)	FIN-Slide (169 mm)	FIN-Slide (169 mm)	FIN-Slide (169 mm)	FIN-Slide (169 mm)
		U _w 1-sash (W/m ² K) with double/triple glazing U _w 2-sash (W/m ² K) with double/triple glazing with flying mullion R _w Standard (dB) / R _w best value (dB)							
Sash models	Classic-line								
	Classic-line Cristal								
	Slim-line	FIN-Scroll Slim-line 144 uPVC-uPVC	FIN-Scroll Slim-line 156 Aluminium-uPVC		FIN-Slide Slim-line 157 Aluminium-uPVC	FIN-Slide Slim-line 169 Aluminium-aluminium	FIN-Slide Slim-line 169 Aluminium-wood		
		1.3 / 1.1 1.3 / 1.2	1.3 / 1.2 1.4 / 1.3		1.4 / 0.84 1.4 / 0.95	1.4 / 0.95 1.5 / 1.0	1.3 / 0.84 1.4 / 0.95		
		npd	npd		npd	npd	npd		
	Slim-line Twin								
	Slim-line Cristal				FIN-Slide Slim-line Cristal 157 Aluminium-uPVC	FIN-Slide Slim-line Cristal 169 Aluminium-aluminium	FIN-Slide Slim-line Cristal 169 Aluminium-wood		
					- / 0.95 - / 1.1	- / 0.95 - / 1.1	- / 0.95 - / 1.1		
					npd	npd	npd		
	Slim-line Cristal Twin								
	Step-line			FIN-Slide Step-line 160 uPVC-uPVC	FIN-Slide Step-line 168 Aluminium-uPVC	FIN-Slide Step-line 176 Aluminium-aluminium			
				1.3 / 0.84 1.4 / 0.96	1.3 / 0.86 1.4 / 0.99	1.5 / 1.0 1.5 / 1.1			
			npd	npd	npd				
Step-line Door			FIN-Slide Door Step-line Door 160 uPVC-uPVC	FIN-Slide Door Step-line Door 168 Aluminium-uPVC	FIN-Slide Door Step-line Door 176 Aluminium-aluminium				
			1.3 / 0.85 1.4 / 0.96	1.3 / 0.88 1.4 / 1.0	1.4 / 0.99 1.5 / 1.1				
			npd / 43 (-1;-5)	npd / 43 (-1;-5)	npd				
Step-line Cristal									
Ferro-line									
Ferro-line Cristal									
Nova-line									
Nova-line Plus					FIN-Slide Nova-line Plus 169 Aluminium-aluminium	FIN-Slide Nova-line Plus 169 Aluminium-wood			
					1.4 / 0.87 1.5 / 1.0	- / 0.87 - / 1.0			
					npd	npd			
Nova-line Twin									
Nova-line Plus Cristal					FIN-Slide Nova-line Plus Cristal 169 Aluminium-aluminium				
					- / 0.86 - / 0.98				
					npd				
Burglary protection	Standards	At least 2 security locking points	At least 2 security locking points	At least 2 security locking points	At least 2 security locking points	At least 2 security locking points	At least 2 security locking points	At least 2 security locking points	
Colour/Finish	Exterior	10 uPVC colours	252 aluminium colours	10 uPVC colours	252 aluminium colours	252 aluminium colours	252 aluminium colours	252 aluminium colours	
	Interior	10 uPVC colours	10 uPVC colours	10 uPVC colours	10 uPVC colours	252 aluminium colours	6 softwood colours, 9 hardwood colours		

Lift-and-slide doors and windows	Folding doors			Window walls		
Aluminium	Aluminium	Aluminium	Aluminium	Aluminium	Aluminium	
uPVC	uPVC	uPVC	uPVC	uPVC	uPVC	
Wood/ceramic/metal	Aluminium	Wood	uPVC	Aluminium	Wood	
FIN-Slide (169 mm)	FIN-Fold (88 mm)	FIN-Fold (97 mm)	FIN-Vista (von 156 mm bis 193 mm)	FIN-Vista (von 169 mm bis 193 mm)	FIN-Vista (from 169 mm to 193 mm)	

U_w 1-sash (W/m²K) with double/triple glazing
 U_w 2-sash (W/m²K) with double/triple glazing with flying mullion
 R_w Standard (dB) / R_w best value (dB)

FIN-Slide Slim-line 169 Aluminium-wood/ceramic/metal	FIN-Fold Slim-line 88 Aluminium-aluminium	FIN-Fold Slim-line 97 Aluminium-wood
1.4 / 0.95 1.5 / 1.0	1.4 / 1.2	1.4 / 1.2
npd	npd	npd

FIN-Vista
 Modular stick (mullion/transom) system for window walls,
 combinable with all windows, sliding and folding doors

	FIN-Fold Nova-line Plus 88 Aluminium-aluminium	FIN-Fold Nova-line Plus 97 Aluminium-wood
	1.4 / 0.90	1.4 / 0.90
	npd	npd

At least 2 security locking points	At least 2 security locking points	At least 2 security locking points	At least 2 security locking points	At least 2 security locking points	At least 2 security locking points
252 aluminium colours	252 aluminium colours	252 aluminium colours	252 aluminium colours	252 aluminium colours	252 aluminium colours
5 precious wood finishes, 5 metal finishes, 12 ceramic finishes	252 aluminium colours	6 softwood colours, 9 hardwood colours	10 uPVC colours	10 uPVC colours	10 uPVC colours

Index

Term	Reference	Page			
Alarm	Exterior → Protection → Burglary Interior → Operation → User comfort	82 231	FIN-Vista	Range Exterior → Design → Frame shape Centre → Building connection → Mounting method	288 ff. 62 ff. 162 f.
All-glass	Exterior → Design → Frame shape Interior → Design → Frame shape Interior → Operation → Options	44 ff., 66 f. 190 ff. 218 f.	FIN-Window	Range Centre → Insulation → Heat/Cold Centre → Insulation → Tightness	288 ff. 122 136
Aluminium	Exterior → Design → Material Exterior → Design → Colour/Finish Interior → Design → Material Interior → Design → Colour/Finish	14 f. 20 ff. 170 f. 176 f.	Fixed glazing	Interior → Design → Frame shape	186 ff.
Angled window	Exterior → Design → Frame shape	60 f.	Flat threshold	Interior → Operation → Opening actions	224 ff.
Arched window	Exterior → Design → Frame shape	60 f.	Flush	Interior → Design → Frame shape	186 ff.
Architect service	Ancillary services → Support → Architect service	270 ff.	Folding door	Interior → Operation → Opening actions	226 f.
Balcony door	Interior → Operation → Opening actions	210 f.	Folding shutter	Exterior → Protection → Sun/Heat	112
Barrier-free	Interior → Operation → Opening actions	212, 226, 232	Frame	Exterior → Design → Frame shape Interior → Design → Frame shape Exterior → Design → Material Interior → Design → Material	52 f. . 14 f. 176 f.
Block frame	Exterior → Design → Frame shape	52			170 f.
Board shutter	Exterior → Protection → Sun/Heat	110	Frame	Exterior → Design → Frame shape Interior → Design → Frame shape	28 ff. 186 ff.
Building connection	Centre → Building connection	138 ff.	Frame-covering glass	Interior → Design → Frame shape Interior → Operation → Opening actions	190 ff. 208 ff.
Burglary protection	Exterior → Protection → Burglary	76 ff.	Frameless	Exterior → Design → Frame shape Interior → Design → Frame shape	26 ff. 186 ff.
Casement door	Interior → Operation → Opening actions	210 f.	Gasket	Centre → Insulation → Tightness Centre → Insulation → Noise	137 130
Certificate	Ancillary services → Support → Warranties/Certificates	264 ff.	Glass	Exterior → Protection → Sun/Heat Centre → Insulation → Heat/Cold	96 f. 120 f.
Child safety lock	Interior → Operation → Safety in use	234	Glass corner	Exterior → Design → Frame shape	66
Classic-line	Exterior → Design → Frame shape	30	Glazing bars	Exterior → Design → Style elements	70 f.
Construction depth	Range Centre → Insulation → Heat/Cold	288 ff. 122	Handle	Interior → Design → Handles/Hinges	198
Coupled sash	Exterior → Design → Frame shape Exterior → Protection → Sun/Heat	34 f., 48 f. 98 f.	Handle	Interior → Design → Handles/Hinges	196 ff.
Cristal	Interior → Design → Frame shape Interior → Operation → Opening actions	190 ff. 218 ff.	Heat protection	Exterior → Protection → Sun/Heat	90 f.
Customer service	Ancillary services → Support → Customer service	268 f.	Hinged shutter	Exterior → Protection → Sun/Heat Centre → Building connection → Mounting method	108 f. 160 f.
dB value, decibels	Centre → Insulation → Noise Range	128 ff. 288 ff.	Hinges	Interior → Design → Handles/Hinges	196 ff.
Design	Exterior → Design Interior → Design	12 ff. 168 ff.	Infill panel	Exterior → Design → Style elements	68 f.
Double glazing	Centre → Insulation → Heat/Cold Range	125 288 ff.	Injury-reducing glass	Interior → Operation → Safety in use Exterior → Protection → Burglary	235 82
Double window	Exterior → Protection → Noise	132 f.	Inlay	Interior → Design → Material Interior → Design → Colour/Finish	170 f. 182 ff.
Drill protection	Exterior → Protection → Burglary	82 ff.	Insect protection	Exterior → Protection → Insects	116 f.
Embossed finish	Interior → Design → Colour/Finish Exterior → Design → Colour/Finish	172 f. 16 ff.	Installation	Centre → Building connection Ancillary services → Procedure → Installation	140 ff. 258 ff.
Enamelled glass	Exterior → Design → Colour/Finish Interior → Design → Material	26 f. 171	Institut für Fenster-technik Rosenheim (ift)	Centre → Building connection → Mounting method Centre → Building connection → Sealing Ancillary services → Procedure → Installation Ancillary services → Support → Warranties/Certificates	140 ff. 166 258 f. 265 ff.
External Venetian blinds	Exterior → Protection → Sun/Heat	104 f.	Insulation	Centre → Insulation	118 ff.
Fabric shade	Exterior → Protection → Sun/Heat	106 f.	Insulation glass	Centre → Insulation → Heat/Cold	124 f.
Façade	Exterior → Design → Frame shape	28 ff.	Insulation perfor- mance	Centre → Insulation → Heat/Cold Range	122 ff. 288 ff.
Fanlight	Exterior → Design → Frame shape Interior → Operation → Opening actions	57 208	Interior shutter	Exterior → Protection → Sun/Heat	111
Ferro-line	Exterior → Design → Frame shape	42	Laminated safety glass	Exterior → Protection → Burglary Interior → Operation → Safety in use	82 235
FIN-Fix	Centre → Building connection → Mounting method	142 f.	Lift-and-slide door	Interior → Design → Frame shape Interior → Operation → Opening actions	194 f. 212 ff.
FIN-Fold	Range Centre → Insulation → Tightness Interior → Operation → Opening actions	288 ff. 136 226 f.	Light transmittance	Exterior → Protection → Sun/Heat Exterior → Protection → Privacy Centre → Insulation → Heat/Cold	90 f. 114 f. 125
FIN-Project	Range Centre → Insulation → Heat/Cold Centre → Insulation → Tightness	288 ff. 123 136	Lockable handle	Interior → Operation → Safety in use Interior → Design → Handles/Hinges Exterior → Protection → Burglary	234 196 ff. 82
FIN-Scroll	Range Centre → Insulation → Tightness Interior → Operation → Opening actions	288 ff. 136 224 f.	Locking cylinder	Exterior → Protection → Burglary	83
FIN-Slide	Range Centre → Insulation → Tightness Interior → Operation → Opening actions	288 ff. 136 228 f.	Matt glass	Exterior → Protection → Privacy	115
			Metallic effect	Exterior → Design → Colour/Finish	24

Middle gasket	Centre → Insulation → Tightness Exterior → Protection → Burglary	137 81, 86, 88	Slide-on installation	Centre → Building connection → Mounting method	152 f.
Milk glass	Exterior → Protection → Privacy	114 f.	Sliding door	Interior → Operation → Opening actions	224 f.
Motorised operation	Interior → Operation → User comfort	231	Sliding shutter	Exterior → Protection → Sun/Heat	112 f.
Motorised ventilator	Interior → Operation → Ventilation	245	Sliding window	Interior → Operation → Opening actions	228 f.
Mounting frame	Centre → Building connection → Mounting method	150 f.	Slim-line	Exterior → Design → Frame shape	32 ff.
Mounting, mounting method	Centre → Building connection → Mounting method Centre → Building connection → Sealing Ancillary services → Procedure → Installation	140 ff. 166 f. 258	Smooth finish	Interior → Design → Colour/Finish Exterior → Design → Colour/Finish	172 f. 16 f.
Mullion	Exterior → Design → Frame shape Interior → Design → Frame shape	29 ff. 189	Solar protection	Exterior → Protection → Sun/Heat Centre → Building connection → Mounting method	94 ff. 158 f.
Noise protection	Centre → Insulation → Noise	128 ff.	Solar protection glass	Exterior → Protection → Sun/Heat	96 f.
Nova-line	Exterior → Design → Frame shape	44 f.	Sound insulation	Centre → Insulation → Noise	131 ff.
Nova-line Plus	Exterior → Design → Frame shape	46 f.	Spacers	Centre → Insulation → Heat/Cold	144 ff.
Offset (not flush)	Interior → Design → Frame shape	186 ff.	Steel window	Exterior → Design → Frame shape	42 f.
P2A	Exterior → Protection → Burglary Interior → Operation → Safety in use	82 235	Step-line	Exterior → Design → Frame shape	38 ff.
P4A	Exterior → Protection → Burglary Interior → Operation → Safety in use	82 235	Stick (mullion/trans- som) system	Exterior → Design → Frame shape	62 ff.
P5A	Exterior → Protection → Burglary Interior → Operation → Safety in use	82 235	Sublight	Exterior → Design → Frame shape	57
Parallel sliding door	Interior → Operation → Opening actions	222 f.	Thermal insulation	Centre → Insulation → Heat/Cold Range	125 ff. 288 ff.
Patio door	Interior → Operation → Opening actions	198 f.	Threshold	Interior → Operation → Opening actions	210 ff.
Patterned glass	Exterior → Protection → Privacy	114 f.	Tightness	Centre → Insulation → Tightness	136 f.
Pleated blind	Exterior → Protection → Sun/Heat	101	Tilt-and-turn	Interior → Operation → Opening actions	208 f.
Plinth	Exterior → Design → Style elements	72	Toughened safety glass	Interior → Operation → Safety in use	235
Privacy protection	Exterior → Protection → Privacy	114 f.	Triple glazing	Centre → Insulation → Heat/Cold Range	125 288 ff.
Push-button	Interior → Operation → Safety in use Exterior → Protection → Burglary	234 82	Twin	Exterior → Design → Frame shape Exterior → Protection → Sun/Heat	34 f., 48 f. 98 f.
Quality mark	Ancillary services → Support → Certifications	264 f.	uPVC	Exterior → Design → Material Exterior → Design → Colour/Finish Centre → Insulation → Heat/Cold Interior → Design → Material Interior → Design → Colour/Finish	14 f. 16 f. 121 ff. 170 f. 172 f.
RAL colour range	Exterior → Design → Colour/Finish Interior → Design → Colour/Finish	20 f. 176 f.	uPVC	Exterior → Design → Material Exterior → Design → Colour/Finish Centre → Insulation → Heat/Cold Interior → Design → Material Interior → Design → Colour/Finish	14 f. 16 f. 121 ff. 170 f. 172 f.
RC 2	Exterior → Protection → Burglary	88 f.	U-value, U_w-value	Range Centre → Insulation → Heat/Cold	288 ff. 120 ff.
RC 3	Exterior → Protection → Burglary	88 f.	VdS (German Asso- ciation of Property Insurers)	Exterior → Protection → Burglary	88
Recycling	Exterior → Design → Material Centre → Building connection → Mounting method Ancillary services → Support	14 148 ff. 268	Venetian blind	Exterior → Protection → Sun/Heat	100
Refurbishment	Centre → Building connection → Mounting method Ancillary services → Procedure → Installation	146 ff. 258	Ventilation functions	Interior → Operation → Ventilation	240 ff.
Ribbon windows	Exterior → Design → Frame shape	58 f.	Ventilation sash	Exterior → Protection → Burglary Interior → Operation → Ventilation	83 242 f.
Roller mushroom head bolts	Exterior → Protection → Burglary Interior → Operation → User comfort	80 ff. 230	Warm edge	Centre → Insulation → Heat/Cold	121 ff.
Roller shutter	Exterior → Protection → Sun/Heat Interior → Design → Accessories Centre → Building connection → Mounting method	102 f. 204 f. 158 f.	Weatherstrip	Centre → Insulation → Tightness	137
Round arch	Exterior → Design → Frame shape	60	Window (rebate) ventilator	Interior → Operation → Ventilation	244 f.
Safety glass	Exterior → Protection → Burglary Interior → Operation → Safety in use	82 ff. 235	Window replacement	Centre → Building connection → Mounting method Ancillary services → Procedure → Installation	146 ff. 258
Screwdriver	Exterior → Protection → Burglary	76	Window sensor	Exterior → Protection → Burglary Interior → Operation → User comfort	82 231
Sealing	Centre → Building connection → Sealing	166	Window shutter	Exterior → Protection → Sun/Heat	95, 111
Security	Exterior → Protection → Burglary Interior → Operation → Safety in use	80 ff. 234 f.	Window types	Exterior → Design → Frame shape	186 ff.
Security hardware, security locking	Exterior → Protection → Burglary	80 ff.	Window wall	Exterior → Design → Frame shape Centre → Building connection → Mounting method	62 ff. 162 f.
Security infill panel	Exterior → Protection → Burglary	83	Windowsill	Exterior → Design → Style elements Interior → Design → Accessories	73 203
Sensor	Exterior → Protection → Burglary Interior → Operation → User comfort	82 231	Wood	Interior → Design → Colour/Finish Interior → Design → Material	178 ff. 170 f.
Side-hung door	Interior → Operation → Opening actions	210	Wood decor	Interior → Design → Colour/Finish Exterior → Design → Colour/Finish	174 f. 18 f.
Slide-in installation	Centre → Building connection → Mounting method	254 ff.			

Finstral doors. This is where home begins.

Our doors, like our windows, offer the greatest possible variety. And always coupled with maximum freedom in the design of your model. Thanks to its consistent modularity, virtually everything in our door range is combinable with everything else.

Would you like to design your very own dream door? Nothing could be easier
Just use our door configurator.

www.doorconfigurator.finstral.com

Order our door catalogue:

finstral.com/prospectuses



Image credits

U1, U2 Gerhardt Kellermann	p. 139, 140, 157 Erik Mosoni	p. 261 Paola Corsini, Jens Weber
p. 3 Orla Connolly	p. 169 Gerhardt Kellermann	p. 262 Meraner & Hauser
p. 4 ift, Juanan Barros, Markus Burke	p. 193 Jens Weber	p. 263 Erik Mosoni
p. 5 Love Architecture, Markus Burke	p. 201 Meraner & Hauser	p. 265 Erik Mosoni
p. 6 Lars Borges	p. 220 Liesbeth van Asselt	p. 269 Gerhardt Kellermann
p. 7 Gerhardt Kellermann	p. 221 Sven Scholten	p. 271 Erik Mosoni
p. 8 Tobias Kaser, Gerhardt Kellermann	p. 232 Orla Connolly	p. 273 Erik Mosoni
p. 9 Erik Mosoni	p. 233 Ludger Paffrath	p. 274 Juanan Barros
p. 10 Lars Borges	p. 239 Paola Corsini	p. 275 M. Frenzel, Jens Weber
p. 12 Detlef Podehl	p. 242 Meraner & Hauser	p. 276 Jens Weber, Jasmin Schuller
p. 13 Gerhardt Kellermann	p. 247 Jo Henker	p. 277 Meraner & Hauser
p. 25 Gerhardt Kellermann	p. 248 Jo Henker	p. 279 Orla Connolly
p. 55 Valentin Bianchi	p. 249 Marek Vogel	p. 281, 283 Markus Burke
p. 79 ift	p. 250 Lars Borges, Erik Mosoni	p. 282 Martin Friedrich
p. 93 Juanan Barros	p. 251 Lars Borges	p. 284, 286 Erik Mosoni
p. 119 Gerhardt Kellermann	p. 259 Erik Mosoni	p. 294 Martin Schropp
p. 127 Markus Burke	p. 260 Juanan Barros	

All other images: Archive and stock of Finstral AG

Copyright

© Finstral AG, Unterinn/Ritten, 2025

All rights reserved.

The Finstral logo is a registered figurative mark of Finstral AG.

The name "Finstral" is a registered word mark of Finstral AG.

Edition dated June 2025

Item number 61-1000-00-07

Subject to technical changes. Colour may differ from original products owing to printing processes. The presentation and description of the products in the catalogue are for indicative purposes only. Should the delivered product deviate in any way from the product appearing in the advertising material, then this shall not constitute a defect or deviation as only the order is authoritative.



Colour representation similar.

Binding colour samples are available from your specialist consultant or at finstral.com/samples

Experience windows anew. Visit us at the Finstral Studio.

Talk directly to a specialist consultant:

Visit partner: finstral.com/dealer-search

Chat online: finstral.com

Your nearest Finstral partner:

Finstral Studio Unterinn

Headquarters, 600 m² exhibition area

Unterinn/Ritten, Italy

T +39 0471 296611

finstral.com/unterinn

Finstral Studio Borehamwood

Showroom, 210 m² exhibition area

Premier House, Elstree Way

Borehamwood, Hertfordshire, WD6 1JH

finstral.com/borehamwood